

REI

GAROFOLI

FIRMA LE VERE PORTE IN LEGNO MASSICCIO

REI GAROFOLI.

Il Gruppo Garofoli si colloca tra i leader mondiali nella progettazione, costruzione e commercializzazione di porte per interni, con particolare specializzazione per le porte in legno massiccio. Il Gruppo, guidato dal fondatore Fernando Garofoli, si posiziona nel segmento più alto del mercato di riferimento. Oggi i suoi prodotti sono diventati concreti simboli d'eccellenza del "Made in Italy" nel mondo. Dalle porte classiche in legno massello ai prodotti di design in acciaio spazzolato e alluminio, la Garofoli s.p.a. è in grado di rispondere alle richieste di un mercato sempre più evoluto, seguendo i criteri consoni all'interior design di ultima generazione. Particolarmente attenta al tema della sicurezza, Garofoli propone un'ampia collezione di porte REI dedicate ad alberghi, residence, imprese, istituti scolastici e comunità. Una soluzione ottimale per proteggere la propria struttura nel rispetto delle normative di legge.

The Garofoli Group is a world leader in the design, construction and sale of interior doors, with particular emphasis on solid wood doors. The Group, led by its founder Fernando Garofoli, is positioned in the highest end of the reference market. Today, its products have become tangible symbols of the excellence of "Made in Italy" worldwide. From classic solid wood doors to design brushed steel and aluminium products, Garofoli s.p.a. can meet the demands of an increasingly evolved market, in accordance with the latest generation interior design criteria. Particularly attentive to security matters, Garofoli offers a wide range of REI doors devoted to hotels, resorts, business, schools and community institutes. An ideal solution for protecting your own building in full compliance with legal regulations.

INDEX

4 Stilia REI 30

24 Timber REI 30

38 Filomuro REI 30

52 Poema REI 30

62 Plania REI 60

76 Gdesign REI 60

90 Filomuro REI 60

110 Gold REI 60

124 REI 120

142 Filomuro REI 120

152 Accessori, maniglioni e barre antipanico
Accessories, large handles and panic bars

170 Cataloghi prodotti Garofoli coordinabili
Coordinated Garofoli product catalogues

171 Certificati REI / REI Certificates

172 Reference List Selection

Stilia REI 30_

- | | | | | | | | | |
|---|--|---|---|--------------------------------------|-------------------------------------|-------------------------------|--|---|
| 1 | 2 | 3 | 4 | 5 | 6 | 7 | 8 | 9 |
| VERSIONE
CON
FINITURA
LEGNO
WOOD
FINISH
VERSION | VERSIONE
IN
LAMINATO
LAMINATE
VERSION. | VERSIONE
LACCATA.
LACQUERED
VERSION. | RESISTENZA
AL FUOCO
30 MINUTI.
FIRE
RESISTANCE
30 MINUTES. | PORTA
SINGOLA.
SINGLE
DOOR. | PORTA
DOPPIA.
DOUBLE
DOOR. | PROVA FUMI.
SMOKE
TEST. | FONO
ISOLAMENTO
32 db
37 db
SOUND
INSULATION
32 db
37 db. | PORTA
KLIMA
2 (b)
3
DOOR
KLIMA
2 (b)
3 |

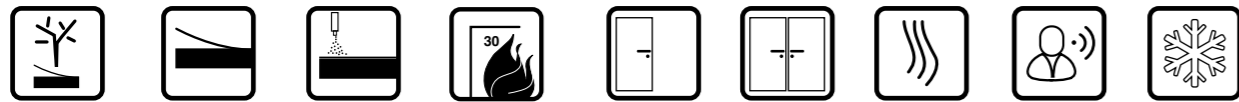

CARATTERISTICHE E PRESTAZIONI:

Porta resistente al fuoco in legno ad un'anta avente classificazione EI 30 - REI 30. Telaio sp. 39 mm. Mostre telescopiche del tipo ad incastro regolabili. Guarnizione acustica fumi freddi estrusa. Guarnizione intumescente autoadesiva. Montaggio consentito su pareti in muratura o cartongesso da sp. mm. 80 minimo con resistenza al fuoco EI 30 - REI 30. Anta sp. 42,5 mm, per finitura complanare lato a tirare al telaio e mostrine. Guarnizioni intumescenti sui bordi dell'anta.

CHARACTERISTICS AND PERFORMANCE:

Wooden - single leaf fire resistant door with EI 30 performance. Main frame 39 mm thick. Adjustable telescopic trims. Extruded cold smoke seal. Intumescent autoadhesive seal. Installation allowed on gypsum board or masonry walls with minimum thickness of 80 mm and EI 30 fire resistance. 42,5 mm leaf which is flush to frame in the pull side. Intumescent gasket on the frame.



STILIA REI 30, ROVERE TABACCO.

STILIA REI 30, TOBACCO OAK.

Stilia REI 30_

STILIA REI 30 VERSIONE LEGNO
ROVERE TABACCO CON
BOISERIE ABBINATA.

STILIA REI 30 TOBACCO OAK
WITH MATCHING PANELLING.

Stilia REI 30_

STILIA REI 30 VERSIONE
CON FINITURA LEGNO
ROVERE TABACCO
CON MENSOLE E BOISERIE
ABBINATA.

STILIA REI 30 TOBACCO OAK
WITH MATCHING PANELLING
AND SHELVES.



Stilia REI 30

BOISERIE E CABINA ARMADIO ABBINATE
ALLA PORTA STILIA REI 30.

PANELLING AND WALK-IN CABINET
MATCHING STILIA REI 30 DOOR FINISH.



Stilia REI 30_

STILIA REI 30 VERSIONE LAMINATO
FRASSINO AVORIO CON MOSTRINE
LISCE E INSERTI METALLICI.
VISTA LATO ESTERNO E VISTA LATO
INTERNO.

STILIA REI 30 IVORY ASH LAMINATE
VERSION WITH SMOOTH TRIMS AND
METAL INSERTS. PUSH SIDE VIEW
AND PULL SIDE VIEW.

Stilia REI 30_

STILIA REI 30, VERSIONE
LAMINATO ROVERE
INTARSIO, MODELLO
LISCIO 1L.

STILIA REI 30 LAMINATED
VERSION, INLAID OAK,
1L MODEL.



Stilia REI 30_

Stilia REI 30_

STILIA REI 30, VERSIONE
LAMINATO OLMO GRIGIO,
MODELLO LISCIO 1L.

STILIA REI 30 LAMINATED
VERSION, GREY ELM,
1L MODEL.



Stilia REI 30_



VERSIONE CON FINITURA LEGNO
WOOD FINISH VERSION

ESSENZE DISPONIBILI (rovere solo venatura orizzontale)

AVAILABLE FINISHES
(oak finishes only available with horizontal grain)



ROVERE TABACCO TOBACCO OAK	ROVERE GRIGIO GREY OAK	ROVERE SBIANCATO BLEACHED OAK	ROVERE LACCATO BIANCO A PORO APERTO WHITE LACQUERED OAK OPEN-PORE	ROVERE LACCATO RAL 9010 A PORO APERTO OAK LACQUERED RAL 9010 OPEN-PORE
ROVERE WENGÈ WENGÈ OAK	ROVERE CASTAGNO CHESTNUT OAK	ROVERE TEAK TEAK OAK	ROVERE LACCATO AVORIO A PORO APERTO IVORY LACQUERED OAK OPEN-PORE	ROVERE LACCATO AVORIO A PORO APERTO IVORY LACQUERED OAK OPEN-PORE
ROVERE PIETRA STONE OAK	ROVERE GRIGIO CRETA CLAY GREY OAK	ROVERE TERRA EARTH OAK	ROVERE LACCATO TORTORA A PORO APERTO DOVE GRAY LACQUERED OAK OPEN-PORE	ROVERE LACCATO TORTORA A PORO APERTO DOVE GRAY LACQUERED OAK OPEN-PORE
ROVERE SETA SILK OAK	ROVERE ICE ICE OAK			

MODELLI DISPONIBILI AVAILABLE MODELS

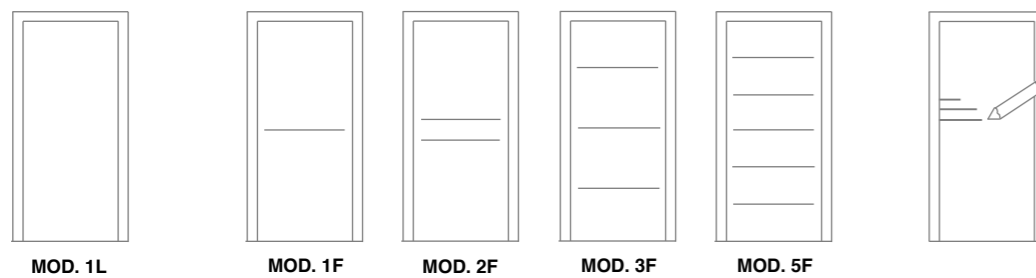

PANTOGRAFATURE (SOLO SU ROVERE LACCATO A PORO APERTO)
RIFERIMENTO MODELLI:
MIRAQUADRA
MIRAWOOD

PANTOGRAPHED (ONLY AVAILABLE FOR LACQUERED OAK OPEN-PORE)
MODELS AVAILABLE:
MIRAQUADRA
MIRAWOOD



VERSIONE IN LAMINATO
LAMINATE VERSION



ESSENZE DISPONIBILI AVAILABLE FINISHES

ROVERE SBIANCATO BLEACHED OAK	ROVERE WENGÈ WENGÈ OAK	ROVERE INTARSIO INLAID OAK	FRASSINO BIANCO WHITE ASH	FRASSINO AVORIO IVORY ASH	FRASSINO TORTORA DOVE GREY ASH
QUERCIA BIANCO QUERCIA WHITE	QUERCIA GESSO QUERCIA OFF-WHITE	QUERCIA SBIANCATO QUERCIA BLEACHED	QUERCIA BIONDO QUERCIA BLONDE	QUERCIA GRIGIO QUERCIA GREY	QUERCIA DECAPÈ QUERCIA PICKLED
QUERCIA SCURO QUERCIA DARK	OLMO GHIACCIO ICE ELM	OLMO SABBIA SAND ELM	OLMO GRIGIO GREY ELM	BIANCO VENATO GRAINED WHITE	NOCE CANALETTO CANALETTO WALNUT
MALTA BIANCO WHITE CEMENT	MALTA NUVOLA CLOUD CEMENT	MALTA CEMENTO PURE CEMENT	MALTA TECHNO TECHNO CEMENT	MALTA GRIGIO GREY CEMENT	MALTA CORTEN WHITE CORTEN
BIANCO TRAMA WHITE WEAVE	BIANCO ARTE ART WHITE	BIANCO CORTECCIA WHITE BARK	BIANCO LASER LASER WHITE	BIANCO ONDA WAVE WHITE	BIANCO QUADRO QUADRO WHITE
MALTA ORO GRIGIO GREY GOLD CEMENT	MALTA ORO NERO BLACK GOLD CEMENT	MALTA SABBIA WHITE SAND	BIANCO WHITE	AVORIO IVORY	

MODELLI DISPONIBILI AVAILABLE MODELS

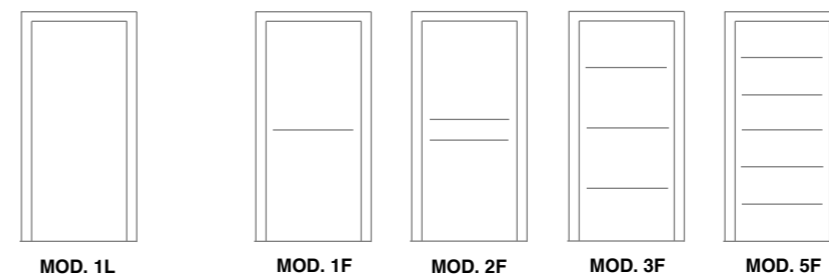

1. TELAIO E MOSTRINE LISCE
NON TEXTURIZZATI
NON-TEXTURED, SMOOTH
FRAME AND JAMBS

2. TELAIO E MOSTRINE
BIANCO LISCIO
WHITE SMOOTH FRAME
AND JAMBS

Stilia REI 30

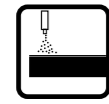

VERSIONE LACCATA
LACQUERED VERSION

COLORI DISPONIBILI COLOURS AVAILABLE

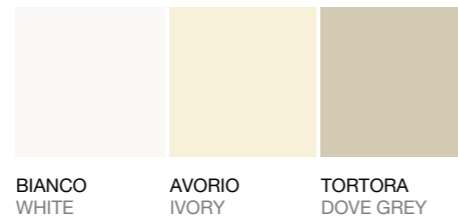

BIANCO
WHITE

AVORIO
IVORY

TORTORA
DOVE GREY

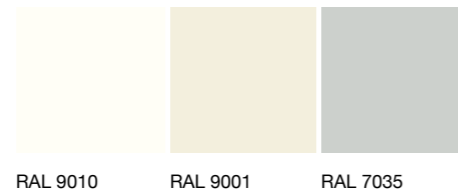

RAL 9010

RAL 9001

RAL 7035

COLORI RAL A RICHIESTA PER STILIA30. RAL COLOURS, UPON REQUEST.



MODELLI DISPONIBILI AVAILABLE MODELS

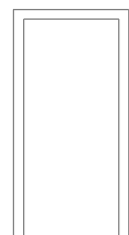

MOD. 1L

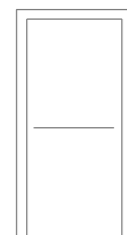

MOD. 1F

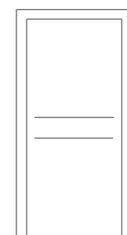

MOD. 2F

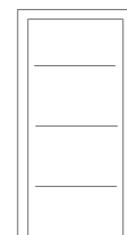

MOD. 3F

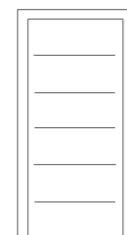

MOD. 5F

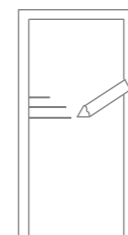

PANTOGRAFATURE
MODELLI:
MIRAQUADRA

PANTOGRAPHED
MODELS AVAILABLE:
MIRAQUADRA

ELEMENTI DI SERIE PER MODELLO STILIA REI 30 STANDARD ELEMENTS FOR MODEL STILIA REI 30

Serratura tipo yale SIC con cilindro chiave-chiave. Cerniere tipo pomella. Chiudiporta integrato pomella auto - chiudente. Elementi: rostri metallici di tenuta e guarnizioni intumescenti.

Yale SIC lock with key-key cylinder. Knob lock hinge 2+1. Built-in door closure device self-closing knob lock. Elements: metal nib sealing elements and intumescent seals.

Questa configurazione è di SERIE per la certificazione UNI 1634-1, per le altre certificazioni potrebbe subire cambiamenti.

This configuration is valid for the "UNI 1634-1" certification. For other certifications, the standard configuration may vary.



A Lato Cerniera tipo pomella.
Knob lock hinges.



B Chiudiporta integrato pomella autochiudente.
Built-in door closure device, self-closing knob lock hinge.

C Serratura yale SIC con cilindro chiave-chiave.
Yale SIC lock with key-key cylinder.



Fornitura standard
3 chiavi
3 keys standard
providing

D Mostrine lisce piatte da 88 mm sia sul lato esterno (spingere porta) sia sul lato interno (tirare porta).
Smooth flat trims size 88 mm on both sides of the door.

E Telaio. Frame.

Le porte REI 30 certificate sono realizzabili esclusivamente nella versione a battente, senza sopraluce.

REI 30 certified doors are only available in the hinged door version, without transom light.

ELEMENTI DI SERIE PER MODELLO STILIA REI 30 DOPPIA

STANDARD ELEMENTS FOR MODEL STILIA REI 30, DOUBLE VERSION

Serratura tipo yale SIC con cilindro chiave-chiave in finitura a scelta ottone lucido o cromo satinato. Cerniere tipo pomella. Chiudiporta aereo a braccio "V". Sequenziatore chiusura ante.

Yale SIC lock with key-key cylinder. Available in different finishes: polished brass or brushed chrome. Knob lock hinges. "V"-shaped overhead door closing arm. Door closure sequencer.

Questa configurazione è di SERIE per la certificazione UNI 1634-1, per le altre certificazioni potrebbe subire cambiamenti. This configuration is valid for the "UNI 1634-1" certification. For other certifications, the standard configuration may vary.



Le porte REI 30 certificate sono realizzabili esclusivamente nella versione a battente, senza sopra-luce. REI 30 certified doors are only available in the hinged door version, without transom light.

- A** Lato cerniera tipo pomella.
Knob lock hinges.



- B** Serratura Tipo yale SIC con cilindro chiave-chiave. Contro-serratura + ferramenta per anta secondaria.
Yale SIC lock with key-key cylinder. Lock striker + hardware for second door.



- C** Chiudiporta aereo a braccio a slitta.
Overhead door closing arm with slide.



- D** Sequenziatore chiusura ante.
Door closer sequencer.



- E** Mostrine lisce piatte da 88 mm. sia sul lato esterno (spingere porta) sia sul lato interno (tirare porta).
Smooth flat trims size 88 mm on both sides of the door.

- F** Telaio. Frame.

Accessori

Accessories

SISTEMI DI CHIUSURA OPTIONAL (a richiesta con supplemento)

OPTIONAL CLOSER SYSTEMS (on request with surcharge)

- C1 - Cerniere tipo a scomparsa regolabili.
C2 - Chiudiporta aereo braccio e con slitta (1° opzione in abbinamento alle cerniere a scomparsa).
C1 - Adjustable hidden hinges.
C2 - Overhead door closer arm with slide (option 1 in combination with concealed hinges).

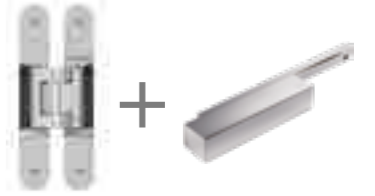

CHIUDIPIORTA (abbinabili sia con cerniere a pomella, che a scomparsa).

DOOR CLOSER SYSTEMS (can be combined with both knob lock and hidden hinges).

- C3 - Chiudiporta a scomparsa incassato (apertura max 120°).
C3 - Recessed concealed door closer (max opening 120°)



- C4 - Chiudiporta aereo braccio a "V", a cremagliera (solo per porta singola, solo con cerniera a pomella).
C4 - "V"-shaped overhead door closing arm with rack (for single door only, only with knob lock hinge).



- C5 - Chiudiporta aereo a braccio e con slitta (per porta singola).
C5 - Overhead door closing arm with slide (for single door).



- C6 - Chiudiporta aereo a braccio e con slitta con sequenziatore di chiusura incorporato (per porta doppia).
C6 - Overhead door closing arm with slide with built-in closer sequencer (for double doors).



KIT FONOIOLANZA

(abbattimento acustico) valido esclusivamente per porta in versione singola.
SOUND INSULATION KIT (sound insulation) valid exclusively for single version door.

- D1 - Livello medio 32db ottenuto con guarnizione saliscendi sotto porta + materiale isolante interno + mastiche sigillante.
D1 - 32db mid level achieved with draught excluder + insulating material inside + sealing mastic.

- D2 - Livello alto 37db ottenuto con guarnizione saliscendi sotto porta + materiale isolante interno + mastiche sigillante.
D2 - 37db high level achieved with draught excluder + insulating material inside + sealing mastic.

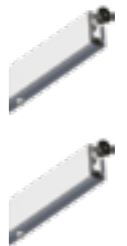

CONTROPIASTRINO ELETTRICO

ELECTRIC STRIKE PLATE

L21 - Posizionato sul montante telaio della porta dal lato maniglia. Accessorio predisposto per essere collegato ad un dispositivo elettronico per lo sblocco dello scrocco maniglia.

L21 - Positioned on the door frame upper on the handle side. Accessory designed for connection to an electronic device for releasing the handle latch.



Per serrature optional, supplementi per mostrine di larghezza maggiorata, maggiorazioni per misure non standard: consultare il listino prezzi.

For optional locks, surcharges for oversized width trims, surcharges for non-standard sizes: consult the price list.

Stilia REI 30_

INFORMAZIONI TECNICHE TECHNICAL DATA.

CARATTERISTICHE E PRESTAZIONI:

Certificata EI30 secondo UNI EN1634-1:2009. Prodotto omologato come da art.1 del D.M. 30/06/2004 dal Ministero dell'Interno con atto di omologazione AN170EI1030P014.

CHARACTERISTICS AND PERFORMANCE:

EI30 certification in accordance with UNI EN1634-1:2009. Product type-approved in accordance with art.1 of M.D. of 30/06/2004 issued by the Ministry of the Interior with type approval act AN170EI1030P014.

FONOSOLANZA

Nessun pacchetto acustico incluso di serie

SOUND INSULATION

Sound insulation is not included as standard

Sezione Stilia REI 30_

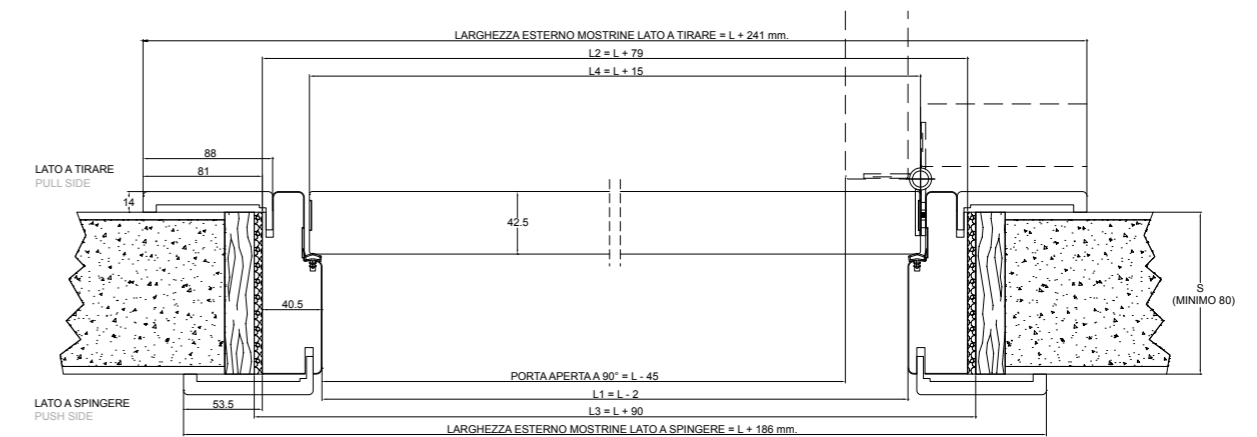

Sezione Stilia REI 30_Doppia

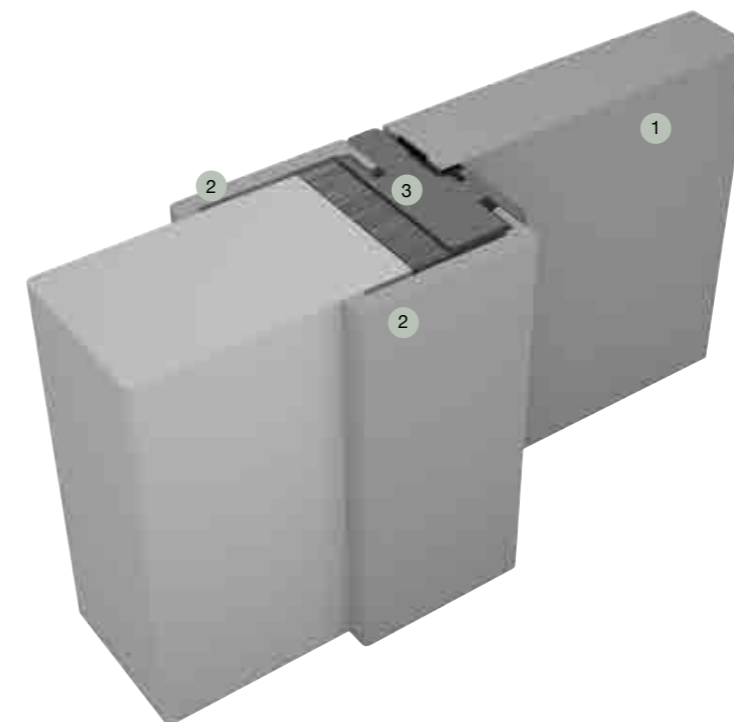
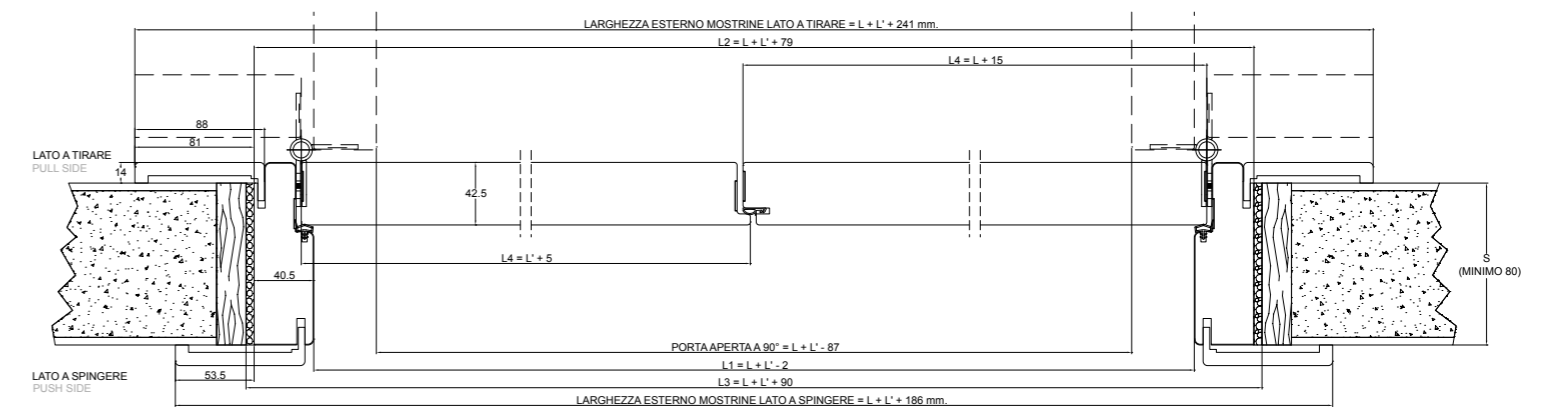

- 1_ANTA.DOOR.
- 2_MOSTRINE.TRIMS.
- 3_TELAIO.FRAME.

Timber REI 30_

- | | | | | | | |
|--|--|---|---|--------------------------------------|---|-------------------------------|
| 1 | 2 | 3 | 4 | 5 | 6 | 7 |
| VERSIONE
IN LEGNO
WOODEN
VERSION. | VERSIONE
CON
FINITURA
LEGNO
WOOD
FINISH
VERSION. | VERSIONE
LACCATA.
LACQUERED
VERSION. | RESISTENZA
AL FUOCO
30 MINUTI.
FIRE
RESISTANCE
30 MINUTES. | PORTA
SINGOLA.
SINGLE
DOOR. | FONO
ISOLAMENTO
31 db
36 db
40 db
SOUND
INSULATION
31 db
36 db
40 db | PROVA FUMI.
SMOKE
TEST. |



CARATTERISTICHE E PRESTAZIONI:

Porta resistente al fuoco in legno ad un'anta avente classificazione EI 30 - REI 30. Telaio sp. 44 mm. Mostre telescopiche regolabili. Guarnizione acustica fumi freddi estrusa. Guarnizione intumescente autoadesiva. Montaggio consentito su pareti in muratura o cartongesso da sp. mm. 110 minimo con resistenza al fuoco EI 30 - REI 30. Anta sp. 60 mm. Possibilità di inserire telaio tipo "mirabilia" (solo per finiture laccate) con mostrine da 72 mm o telaio tipo "TOT" con mostrine da 88 mm.

CHARACTERISTICS AND PERFORMANCE:

Wooden - single leaf fire resistant door with REI30 performance. Main frame, 44 mm thick. Adjustable telescopic covering profiles. Extruded cold smoke seal. Intumescent autoadhesive seal. Installation allowed on gypsum board or masonry walls with minimum thickness of 110 mm and EI 30 fire resistance. Leaf 60 mm thick. Optional: "Mirabilia" frame (only for lacquered finishes) with 72 mm trims, or "TOT" frame with 88 mm trims.



TIMBER REI 30, FINITURA
ASCERRY SCURO,
MODELLO 3BE.

TIMBER REI 30, DARK
ASCERRY FINISH,
MOD. 3BE.

Timber REI 30

TIMBER REI 30
ROVERE TABACCO
MODELLO 2BC.

TIMBER REI 30
TOBACCO OAK
MODEL 2BC.

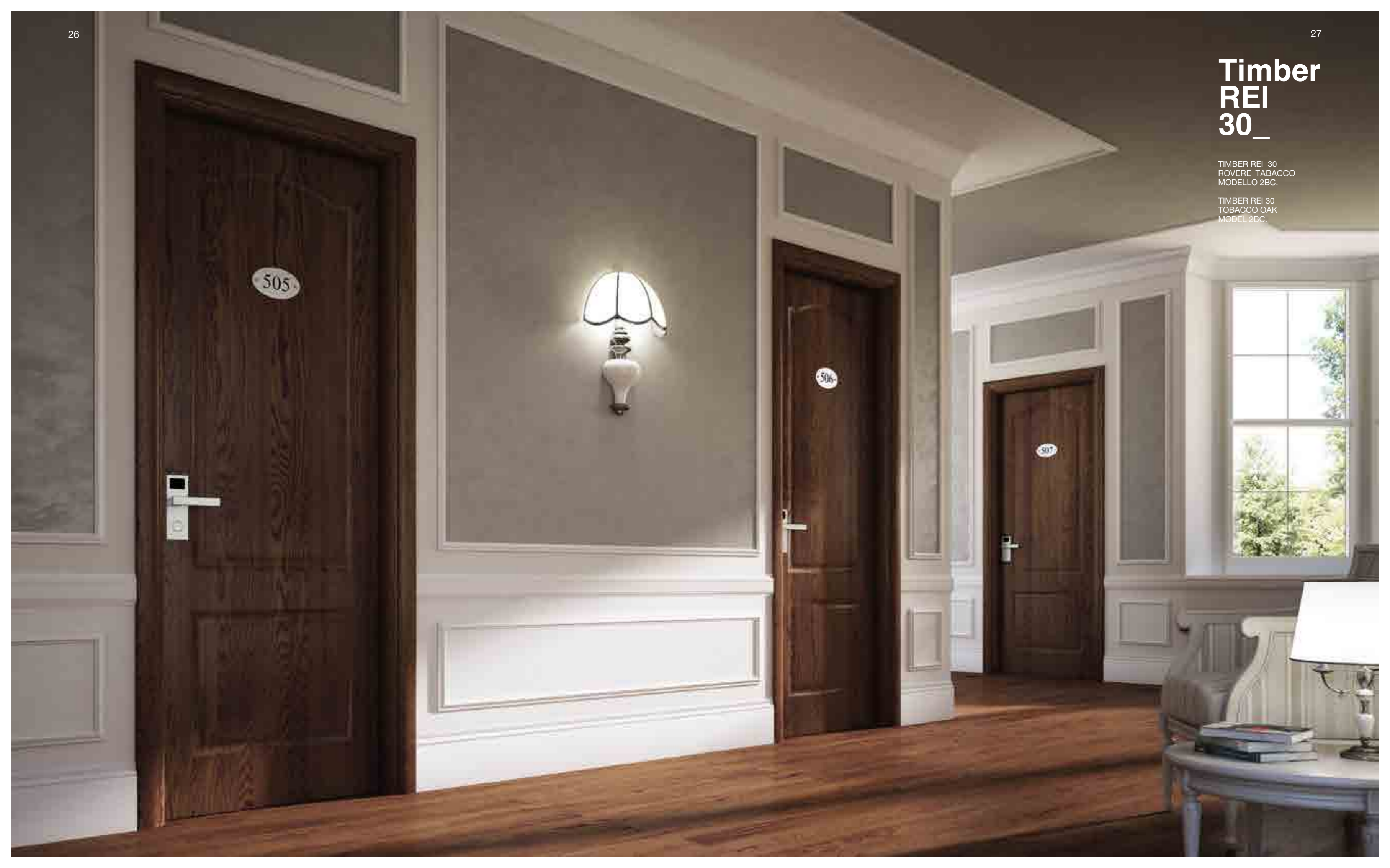

Timber REI 30_

TIMBER REI 30 ROVERE
SBIANCATO MODELLO 1F
CON FILETTO METALLICO
CROMO SATINATO.

TIMBER REI 30 BLEACHED
OAK MODEL 1F WITH
SATIN-FINISH CHROME
METAL INSERT.



Timber REI 30_



VERSIONE IN LEGNO
WOODEN VERSION



VERSIONE CON FINITURA LEGNO
WOOD FINISH VERSION.



ESSENZE DISPONIBILI
(rovere venatura orizzontale o verticale)
AVAILABLE FINISHES
(oak with horizontal or vertical finish)

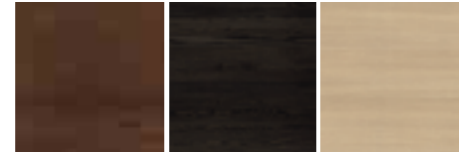

ROVERE
TABACCO
TOBACCO OAK

ROVERE
GRIGIO
GREY OAK

ROVERE
SBIANCATO
BLEACHED OAK

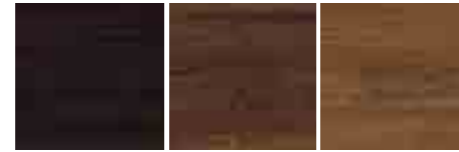

ROVERE
WENGÈ
WENGÈ OAK

ROVERE
CASTAGNO
CHESTNUT OAK

ROVERE
TEAK
TEAK OAK

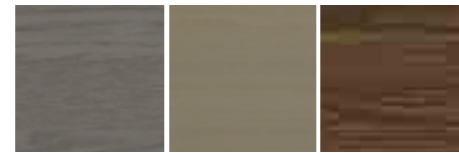

ROVERE
PIETRA
STONE OAK

ROVERE
GRIGIO CRETA
CLAY GREY OAK

ROVERE
TERRA
EARTH OAK



ROVERE
SETA
SILK OAK

ROVERE
ICE
ICE OAK

COLORI DISPONIBILI
(solo venatura orizzontale)
AVAILABLE FINISHES
(only for horizontal wood grain)



ROVERE
LACCATO
BIANCO
A PORO APERTO
WHITE
LACQUERED
OAK OPEN-PORE

ROVERE
LACCATO RAL
9010
A PORO APERTO
OAK LACQUERED
RAL 9010 OPEN-
PORE



ROVERE
LACCATO
AVORIO
A PORO APERTO
IVORY
LACQUERED
OAK OPEN-PORE

ROVERE
LACCATO RAL
9001
A PORO APERTO
OAK LACQUERED
RAL 9001 OPEN-
PORE



ROVERE
LACCATO
TORTORA
A PORO
APERTO
DOVE GRAY
LACQUERED
OAK OPEN-
PORE

ROVERE
LACCATO RAL
7035
A PORO APERTO
OAK LACQUERED
RAL 7035 OPEN-
PORE

MODELLI DISPONIBILI.
AVAILABLE MODELS

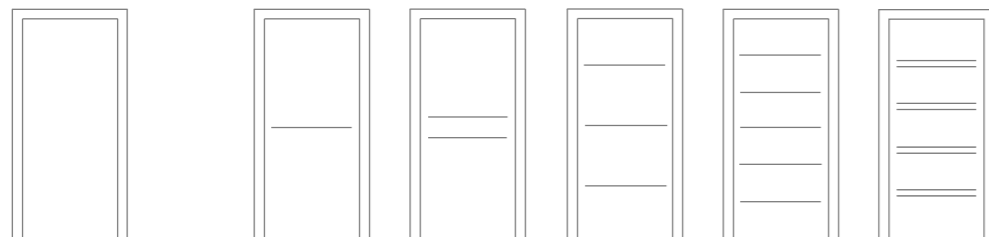

MOD. 1L MOD. 1F MOD. 2F MOD. 3F MOD. 5F MOD. 8F

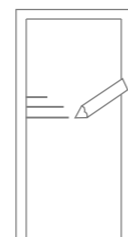

PANTOGRAFATURE
MOD. MIRAQUADRA
MIRABILIA, SUBLIMIA,
PANGEA DORE.

PANTOGRAPHED
MODELS AVAILABLE:
MOD. MIRAQUADRA
MIRABILIA, SUBLIMIA,
PANGEA DORE.



VERSIONE CON FINITURA LEGNO
WOOD FINISH VERSION.



ESSENZE DISPONIBILI
(solo venature verticali)
AVAILABLE FINISHES
(only for vertical wood grain)



ASCHERRY
CHIARO
ASCHERRY
LIGHT

ASCHERRY
SCURO
ASCHERRY
DARK

CANOEWOOD
CANOEWOOD



ARTE POVERA
ARTE POVERA

SATINE'
SATINE'

MODELLI DISPONIBILI
AVAILABLE MODELS

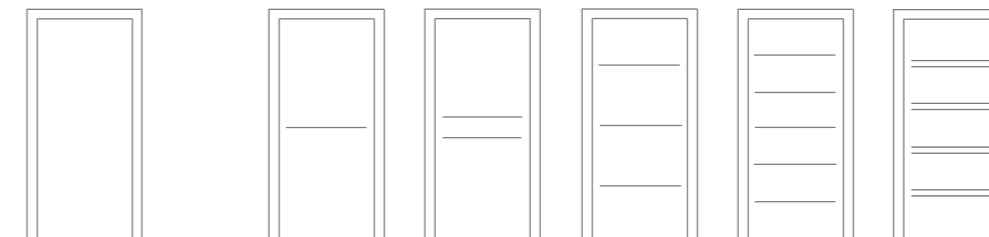

MOD. 1L MOD. 1F MOD. 2F MOD. 3F MOD. 5F MOD. 8F

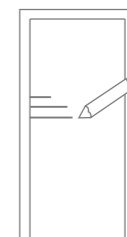

PANTOGRAFATURE
MOD. MIRAQUADRA
MIRABILIA, SUBLIMIA,
PANGEA DORE.

PANTOGRAPHED
MODELS AVAILABLE:
MOD. MIRAQUADRA
MIRABILIA, SUBLIMIA,
PANGEA DORE.

Timber REI 30



VERSIONE LACCATA
LACQUERED VERSION

COLORI DISPONIBILI COLOURS AVAILABLE

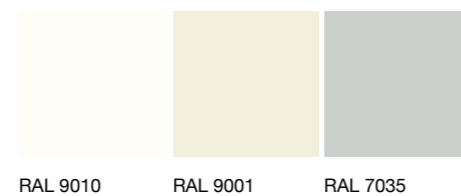
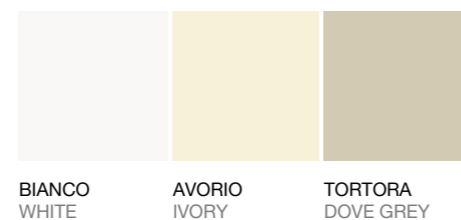

COLORI RAL A RICHIESTA PER STILIA30. RAL COLOURS, UPON REQUEST.



MODELLI DISPONIBILI AVAILABLE MODELS

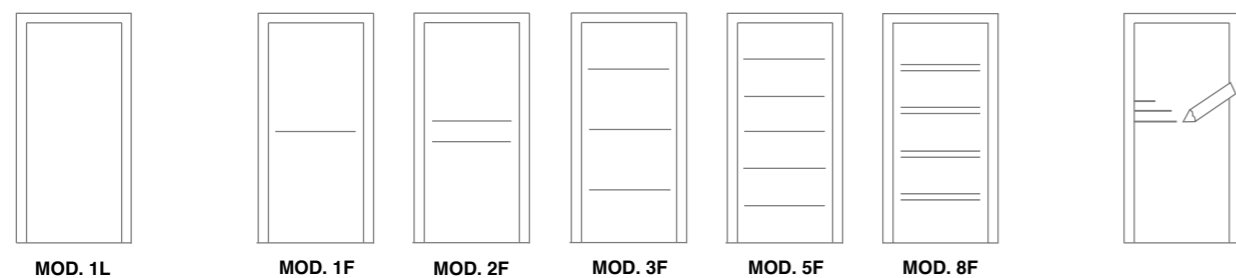

PANTOGRAFATURE
MOD. MIRAQUADRA
MIRABILIA, SUBLIMIA,
PANGEA DORE.

PANTOGRAPHED
MODELS AVAILABLE:
MOD. MIRAQUADRA
MIRABILIA, SUBLIMIA,
PANGEA DORE.

ELEMENTI DI SERIE PER MODELLO TIMBER REI 30 STANDARD ELEMENTS FOR MODEL TIMBER REI 30

Serratura tipo yale SIC con cilindro chiave - chiave in finitura a scelta ottone lucido o cromo satinato (ottone lucido standard di base). Cerniere anuba regolabili (colori: cromo satinato, cromo lucido, ottone lucido). Elementi rostri metallici di tenuta con guarnizioni intumescenti.

Yale SIC lock with key-key cylinder in polished brass or satin chrome finish (basic version polished brass). Adjustable anuba hinges, of which are load bearing and self-closing (colours: satin chrome, polished chrome, polished brass). Metal nib sealing elements with intumescent seals.

Questa configurazione è di SERIE per la certificazione UNI 1634-1, per le altre certificazioni potrebbe subire cambiamenti.

This configuration is valid for the "UNI 1634-1" certification. For other certifications, the standard configuration may vary.



A Lato con cerniere anuba regolabili.
Adjustable anuba hinges.



B Tipo yale SIC con cilindro chiave-chiave.
Yale SIC lock with key-key cylinder.



Fornitura standard
3 chiavi
3 keys standard
providing

C Mostrina piatta da 72mm tipo collezione "Mirabilia".
Flat trim size 72mm from "Mirabilia" collection.

D Telaio dritto.
Plain frame.

Le porte REI 30 certificate sono realizzabili esclusivamente nella versione a battente, ad un'anta e senza sopra-luce.

REI 30 certified doors are only available in the hinged door version, with one leaf and without transom light.

Timber REI 30_

INFORMAZIONI TECNICHE TECHNICAL DATA

CARATTERISTICHE E PRESTAZIONI:

Certificata EI30 secondo UNI EN1634-1:2009. Prodotto omologato come da art.1 del D.M. 30/06/2004 dal Ministero dell'Interno con atto di omologazione AN170EI2030P016.

CHARACTERISTICS AND PERFORMANCE:

EI30 certification in accordance with UNI EN1634-1:2009. Product type-approved in accordance with art.1 of M.D. of 30/06/2004 issued by the Ministry of the Interior with type approval act AN170EI1030P016.

FONOSOLANZA

Nessun pacchetto acustico incluso di serie

SOUND INSULATION

Sound insulation is not included as standard

Sezione Timber REI 30_

Sezione telaio "Stondato" (Optional)

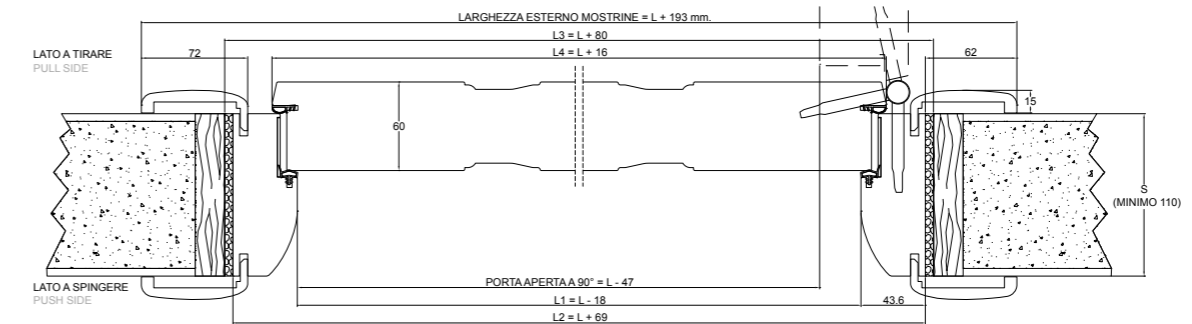

Sezione telaio "Tot" (Optional)

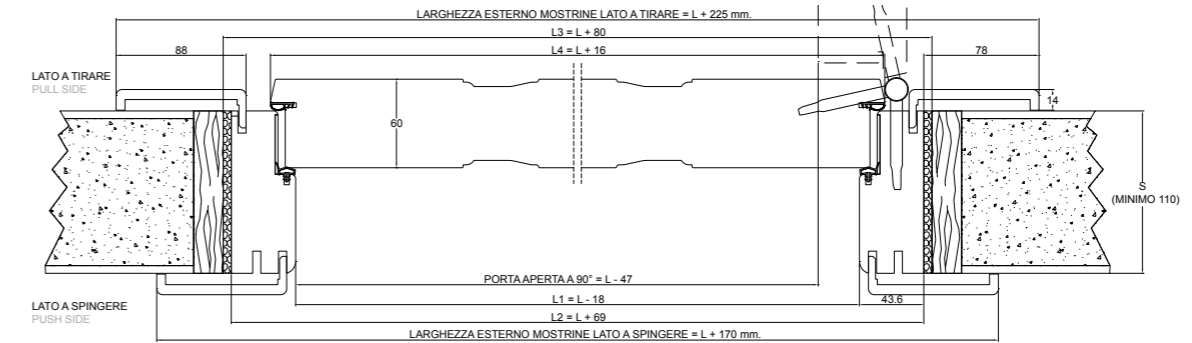

Sezione telaio "Mirabilia" (Solo per versione laccato)

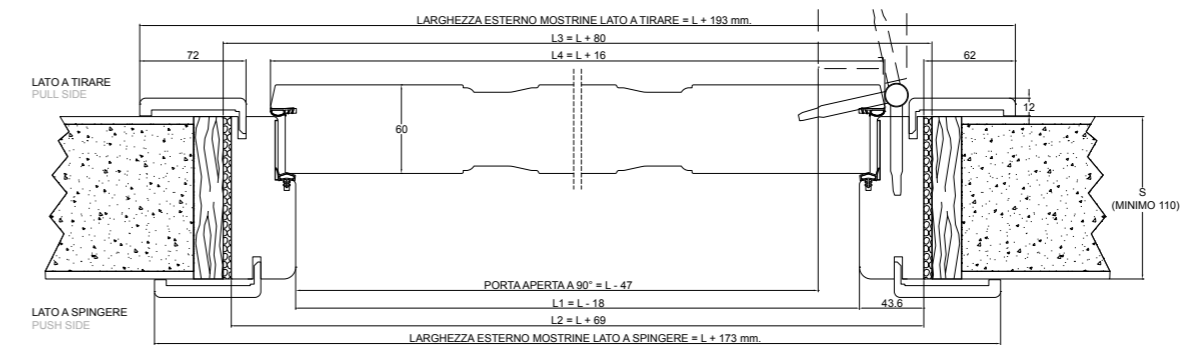

- 1_ANTA.DOOR.
- 2_MOSTRINE.TRIM.
- 3_TELAIO.FRAME.

Sezione telaio "Stondato" (Standard)

- mostrina stondata da 72 mm (di serie)
- "Rounded" frame section (Standard)
- 72 mm rounded trim (standard)

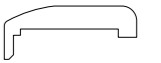

- mostrina liscia da 88 mm (con telaio "TOT")
- 88 mm smooth trim (with frame "Tot")

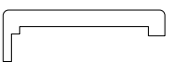

- mostrina liscia da 72 mm (con telaio "Mirabilia")
- 72 mm smooth trim (with frame "Mirabilia")



- mostrina liscia da 120 mm
- 120 mm smooth trim



- mostrina 110eLode
- trim of 110eLode

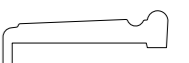

- mostrina Epoque
- "Epoque" trim

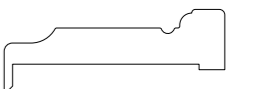

- mostrina Roma
- "Roma" trim

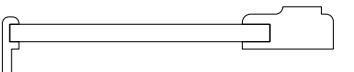

Accessori

Accessories

CHIUDIPIORTA a richiesta con supplemento

DOOR CLOSER SYSTEMS (on request with surcharge)

D1 - Chiudiporta a scomparsa ad incasso lato superiore anta e telaio

D1 - Hidden closing door, on top of door and frame



D2 - Chiudiporta aereo a braccio a "V" a cremagliera (solo con telaio "Tot" o "Mirabilia")

D2 - "V"-shaped overhead door closing arm with rack (only with "Tot" or "Mirabilia" frames)



D3 - Chiudiporta aereo a braccio e con slitta (solo con telaio "Tot" o "Mirabilia")

D3 - Overhead door closing arm with slide (only with "Tot" or "Mirabilia" frames)



KIT FONOIOLANZA

(abbattimento acustico) valido esclusivamente per porta in versione singola

SOUND INSULATION KIT

(sound dampening) valid exclusively for single version door

E1 - Livello base 31 dB ottenuto con sola guarnizione saliscendi sotto porta

E1 - 31 dB base level achieved with sliding seal below door



E2 - Livello medio 36 dB ottenuto con guarnizione saliscendi sotto porta + materiale isolante interno + mastice sigillante

E2 - 36dB mid level achieved with sliding seal below door + insulating material + sealing mastic



E3 - Livello alto 40 dB ottenuto con guarnizione saliscendi sotto porta + materiale isolante interno "special" + mastice sigillante

E3 - 40 dB high level achieved with sliding seal below door + special insulating material + sealing mastic



CONTROPIASTRINO ELETTRICO

ELECTRIC STRIKE PLATE

H20 - Posizionato sul montante telaio della porta dal lato maniglia. Accessorio predisposto per essere collegato ad un dispositivo elettronico per lo sblocco dello scrocco maniglia

H21 - Positioned on the door frame upper on the handle side. Accessory designed for connection to an electronic device for releasing the handle latch



Per serrature optional, supplementi per mostrine di larghezza maggiorata, maggiorazioni per misure non standard consultare il listino prezzi

For optional locks, surcharges for oversized width trims, surcharges for non-standard sizes, consult the price list

Filomuro REI 30_

- | | | | | |
|--|--|--|---|--|
| <p>1
VERSIONE
CON
FINITURA
LEGNO
WOOD
FINISH
VERSION.</p> | <p>2
VERSIONE
LACCATA.
LACQUERED
VERSION.</p> | <p>3
RESISTENZA
AL FUOCO
30 MINUTI.
FIRE
RESISTANCE
30 MINUTES.</p> | <p>4
PORTA
SINGOLA.
SINGLE
DOOR.</p> | <p>5
FONO
ISOLAMENTO
35 db
38 db
40 db
SOUND
INSULATION
35 db
38 db
40 db</p> |
|--|--|--|---|--|
-
- | | | | | |
|---|---|---|---|---|
|  |  |  |  |  |
|---|---|---|---|---|

CARATTERISTICHE E PRESTAZIONI:

Porta resistente al fuoco ad un'anta in legno con telaio in alluminio avente classificazione EI30-Rei30. Telaio estruso da inserire nella muratura o nel cartongesso compreso di guarnizioni per rumore e fumi freddi. Spessore da mm. 100 con resistenza al fuoco EI30- REI30. Anta sp. 45 mm complanare al muro sul lato a spingere o tirare. Guarnizioni intumescenti sul telaio.

CHARACTERISTICS AND PERFORMANCE:

Fire resistant door with aluminum frame having EI30-REI30 classification. Frame to be installed into brickwork or in plasterboard with mm thick. 100 with fire resistance EI30- REI30. 45 mm leaf which can be flush in the pull or push side. Intumescent gasket on the frame.



FILOMURO REI 30 IN
VERSIONE LACCATO
LUCIDO COLORE RAL.

REI 30 FILOMURO
VERSION IN LACQUERED
RAL GLOSSY.

Filomuro REI 30_

FILOMURO REI 30 IN VERSIONE
LACCATO LUCIDO COLORE RAL.

REI 30 FILOMURO VERSION
IN LACQUERED RAL GLOSSY.

276

277



Filomuro REI 30

VERSIONE GREZZA CON PRIMER
UNFINISH VERSION

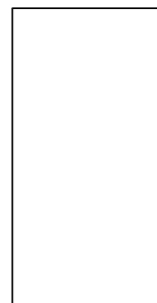

**GREZZA
CON FONDO
INTONACABILE
ENTRambi I LATI.**
UNFINISHED
VERSION
PLASTERABLE ON
BOTH SIDES.

FILOMURO REI 30 IN VERSIONE
INTONACATA.

REI 30 FILOMURO PLASTER
VERSION.



Filomuro REI 30_



VERSIONE CON FINITURA LEGNO
WOOD FINISH VERSION.

ESSENZE DISPONIBILI (rovere venatura orizzontale)

AVAILABLE FINISHES
(oak with horizontal finish)

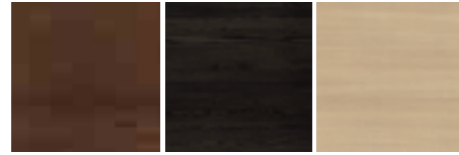

ROVERE
TABACCO
TOBACCO OAK

ROVERE
GRIGIO
GREY OAK

ROVERE
SBIANCATO
BLEACHED OAK

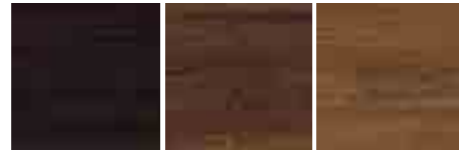

ROVERE
WENGÈ
WENGÈ OAK

ROVERE
CASTAGNO
CHESTNUT OAK

ROVERE
TEAK
TEAK OAK

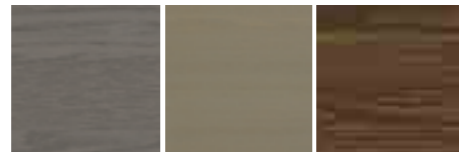

ROVERE
PIETRA
STONE OAK

ROVERE
GRIGIO CRETA
CLAY GREY OAK

ROVERE
TERRA
EARTH OAK



ROVERE
SETA
SILK OAK

ROVERE
ICE
ICE OAK

COLORI DISPONIBILI (solo venatura orizzontale)

AVAILABLE FINISHES
(only for horizontal wood grain)



ROVERE
LACCATO
BIANCO
A PORO APERTO
WHITE
LACQUERED
OAK OPEN-PORE

ROVERE
LACCATO RAL
9010
A PORO APERTO
OAK LACQUERED
RAL 9010 OPEN-
PORE



ROVERE
LACCATO
AVORIO
A PORO APERTO
IVORY
LACQUERED
OAK OPEN-PORE

ROVERE
LACCATO RAL
9001
A PORO APERTO
OAK LACQUERED
RAL 9001 OPEN-
PORE



ROVERE
LACCATO
TORTORA
A PORO
APERTO
DOVE GRAY
LACQUERED
OAK OPEN-
PORE

ROVERE
LACCATO RAL
7035
A PORO APERTO
OAK LACQUERED
RAL 7035 OPEN-
PORE



MODELLI DISPONIBILI AVAILABLE MODELS

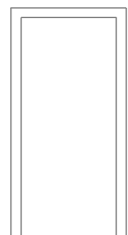

MOD. 1L

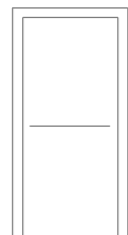

MOD. 1F

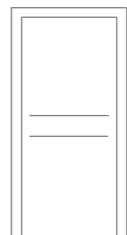

MOD. 2F

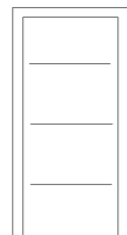

MOD. 3F

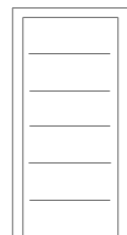

MOD. 5F

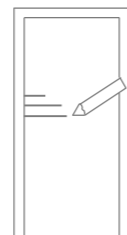

PANTOGRAFATURE
MOD. MIRAQUADRA
MIRABILIA, SUBLIMIA,
PANGEA.

PANTOGRAPHED
MODELS AVAILABLE:
MOD. MIRAQUADRA
MIRABILIA, SUBLIMIA,
PANGEA.



VERSIONE IN LAMINATO
LAMINATE VERSION

ESSENZE DISPONIBILI AVAILABLE FINISHES



ROVERE
SBIANCATO
BLEACHED
OAK

ROVERE
WENGÈ
WENGÈ OAK

ROVERE
INTARSIO
INLAID OAK

FRASSINO
BIANCO¹
WHITE ASH

FRASSINO
AVORIO¹
IVORY ASH

FRASSINO
TORTORA¹
DOVE GREY
ASH



QUERCIA
BIANCO
QUERCIA
WHITE

QUERCIA
GESSO
QUERCIA OFF-
WHITE

QUERCIA
SBIANCATO
QUERCIA
BLEACHED

QUERCIA
BIONDO
QUERCIA
BLONDE

QUERCIA
GRIGIO
QUERCIA
GREY

QUERCIA
DECAPE
QUERCIA
PICKLED

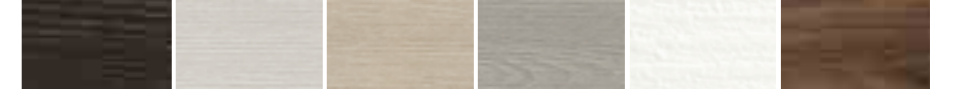

QUERCIA
SCURO
QUERCIA
DARK

OLMO
GHIACCIO
ICE ELM

OLMO
SABBIA
SAND ELM

OLMO
GRIGIO
GREY ELM

BIANCO
VENATO
GRAINED
WHITE

NOCE
CANALETTO
CANALETTO
WALNUT



MALTA
BIANCO
WHITE
CEMENT

MALTA
NUVOLA
CLOUD
CEMENT

MALTA
CEMENTO
PURE CEMENT

MALTA
TECHNO
TECHNO
CEMENT

MALTA
GRIGIO
GREY CEMENT

MALTA
CORTEN
WHITE
CORTEN



BIANCO
TRAMA²
WHITE WEAVE

BIANCO
ARTE²
ART WHITE

BIANCO
CORTECCIA²
WHITE BARK

BIANCO
LASER²
LASER WHITE

BIANCO
ONDA²
WAVE WHITE

BIANCO
QUADRO²
QUADRO
WHITE



MALTA
ORO
GRIGIO
GREY GOLD
CEMENT

MALTA
ORO
NERO
BLACK GOLD
CEMENT

MALTA
SABBIA
WHITE SAND

BIANCO
WHITE

AVORIO
IVORY



MODELLI DISPONIBILI AVAILABLE MODELS

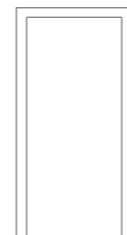

MOD. 1L

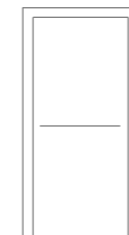

MOD. 1F

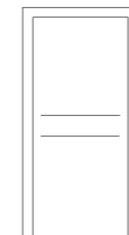

MOD. 2F

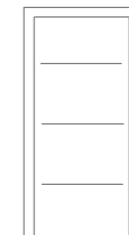

MOD. 3F



MOD. 5F

1. TELAIO E MOSTRINE LISCE
NON TEXTURIZZATI
NON-TEXTURED, SMOOTH
FRAME AND JAMBS

2. TELAIO E MOSTRINE
BIANCO LISCIO
WHITE SMOOTH FRAME
AND JAMBS

Filomuro REI 30_

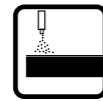

VERSIONE LACCATA.
LACQUERED VERSION.

COLORI DISPONIBILI COLOURS AVAILABLE



BIANCO
WHITE

AVORIO
IVORY

TORTORA
DOVE GREY

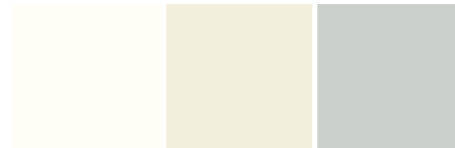

RAL 9010

RAL 9001

RAL 7035

COLORI RAL A RICHIESTA PER STILIA30. RAL COLOURS, UPON REQUEST.



MODELLI DISPONIBILI AVAILABLE MODELS

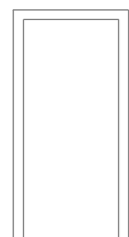

MOD. 1L

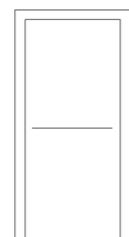

MOD. 1F

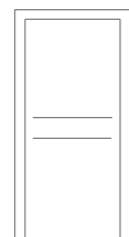

MOD. 2F

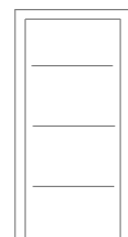

MOD. 3F



MOD. 5F

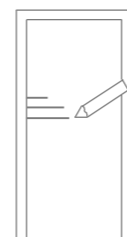

PANTOGRAFATURE
MOD. MIRAQUADRA
MIRABILIA, SUBLIMIA,
PANGEA.

PANTOGRAPHED
MODELS AVAILABLE:
MOD. MIRAQUADRA
MIRABILIA, SUBLIMIA,
PANGEA.

ELEMENTI DI SERIE PER MODELLO FILOMURO REI 30 STANDARD ELEMENTS FOR MODEL REI 30

Serratura tipo yale SIC con cilindro chiave - chiave. Cerniere tipo a scomparsa. Chiudiporta a catena incassato a scomparsa.
Yale SIC lock with key-key cylinder. Concealed hinges spring door closer.

Questa configurazione è di SERIE per la certificazione UNI 1634-1, per le altre certificazioni potrebbe subire cambiamenti.

This configuration is valid for the UNI 1634-1 certification. The standard configuration may vary.

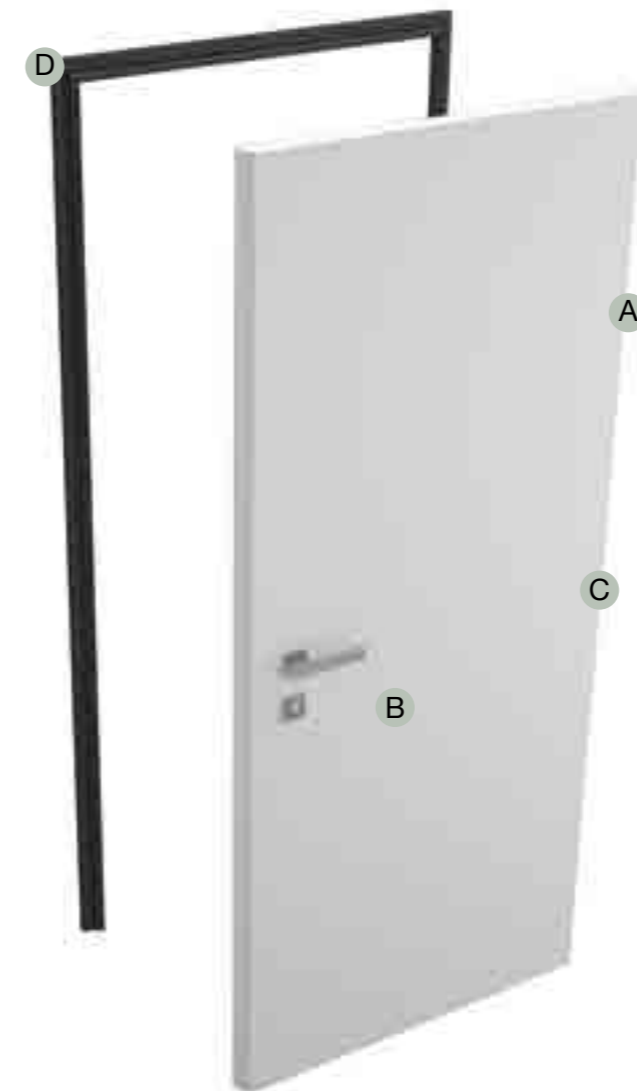

A Lato con cerniere a scomparsa.
Concealed hinges.



B Tipo yale SIC magnetica con cilindro chiave - chiave.
Yale magnetic sic lock with key-key cylinder.



Fornitura standard
3 chiavi
3 keys standard
providing

C Chiudiporta a scomparsa con molla autochiudente.
Spring door closer.



D Telaio In alluminio anodizzato spessore FISSO 45 mm.
Frame in anodised aluminium with FIXED thickness of 45 mm.

Le porte REI 30 certificate sono realizzabili esclusivamente nella versione a battente, ad un'anta e senza sopra luce.

REI 30 certified doors are only available in single hinged version, without transom light.

Filomuro REI 30_

INFORMAZIONI TECNICHE TECHNICAL DATA

CARATTERISTICHE E PRESTAZIONI:

Certificata EI30 secondo UNI EN1634-1:2009. Prodotto omologato come da art.1 del D.M. 30/06/2004 dal Ministero dell'Interno con atto di omologazione AN170EI1030P017.

CHARACTERISTICS AND PERFORMANCE:

EI30 certification in accordance with UNI EN1634-1:2009. Product type-approved in accordance with art.1 of M.D. of 30/06/2004 issued by the Ministry of the Interior with type approval act AN170EI1030P017.

FONOSOLANZA

Nessun pacchetto acustico incluso, di serie.

SOUND INSULATION

Sound insulation is not included as standard.

Sezione Filomuro REI 30_

VERSIONE A
"SPINGERE"
"S" VERSION

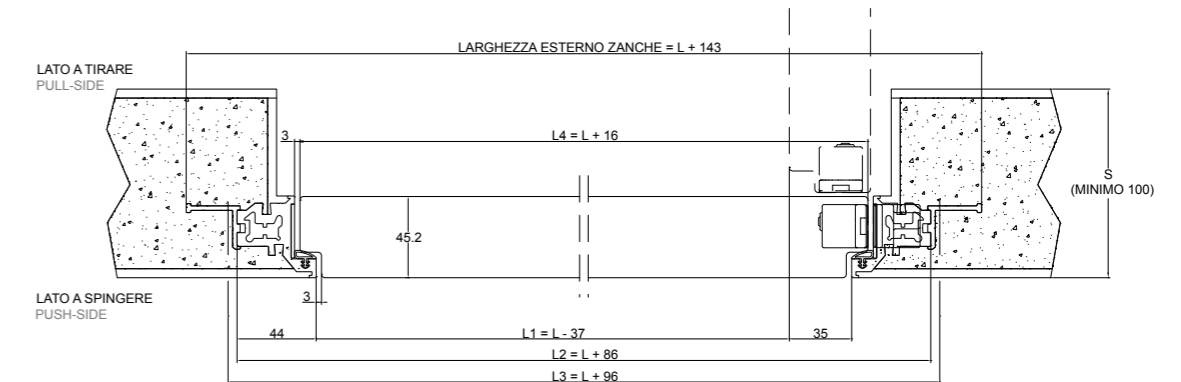

VERSIONE A
"TIRARE"
"T" VERSION

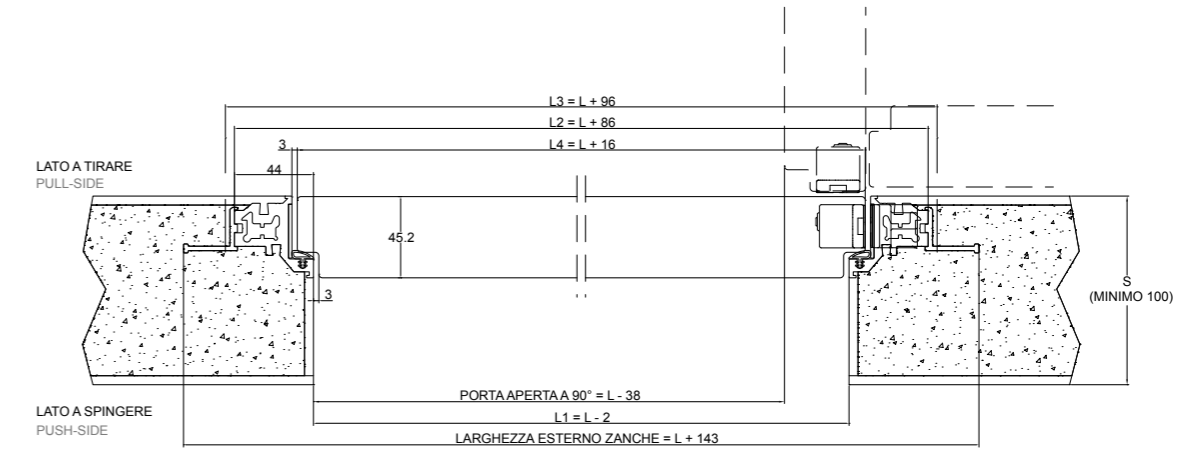

1_ANTA.DOOR.
2_ _TELAIO.FRAME.



Accessori

Accessories

FINITURE - SERVIZI OPTIONAL (a richiesta con supplemento)

FINISHES - OPTIONAL SERVICES (on request with surcharge)

C1 - Gestione anticipata e separata per il solo Telaio.
C1 - Separate production and shipping of the frame.

C2 - Solo telaio 45mm.
C2 - Only 45mm frame.

C3 - Solo telaio in finitura laccato opaco tonalità bianco, avorio o tortora Garofoli
RAL 7035 / RAL 9001 / RAL 9010.
C3 - Frame only with white, ivory or Garofoli light grey matt lacquer finish
RAL 7035 / RAL 9001 / RAL 9010.

C4 - Solo telaio in finitura laccato opaco tonalità RAL.
C4 - Frame only with RAL matt lacquer finish.

C5 - Solo telaio in finitura laccato lucido tonalità bianco, avorio o tortora Garofoli.
C5 - Frame only with white, ivory or Garofoli light grey glossy lacquer finish.

C6 - Solo telaio in finitura laccato lucido tonalità RAL.
C6 - Frame only with RAL glossy lacquer finish.

C7 - Solo telaio in finitura anodizzato nero.
C7 - Frame only with black anodised finish.

CHIUDIPIORTA SOLO PER VERSIONI A”T”

(sistemi di chiusura optional a richiesta con supplemento)

DOOR CLOSURE SYSTEM FOR ”T” - VERSIONS ONLY
(optional closer systems on request with surcharge)

D1 - Chiudiporta a scomparsa incassato (apertura max 120°)
D1 - Recessed concealed door closer (max opening 120°)

D2 - Chiudiporta aereo a braccio a “V” a cremagliera regolabile per forza e velocità apertura max 170°
D2 - Overhead “V” arm door closer and rack gear with adjustable force and speed, max opening 170°

D3 - Chiudiporta aereo a braccio e con slitta regolabile per forza e velocità apertura max 150°
(PER VERSIONE “S”)
D4 - Overhead door closer with arm and slide with adjustable force and speed, max opening 150°
(FOR “S” VERSION)

D4 - Chiudiporta aereo a braccio e con slitta SLIM regolabile per forza e velocità apertura max 150°
D4 - Overhead door closer with arm and SLIM slide with adjustable force and speed, max opening 150°

D4A - Limitatore di apertura per chiudiporta aereo a braccio a slitta.
D4A - Opening limiter for overhead door closer with sliding arm.



KIT FONOIISOLANZA

(abbattimento acustico) valido esclusivamente per porta in versione singola.
SOUND INSULATION KIT
(sound dampening) valid exclusively for single version door.

E1 - Livello base **35 db** ottenuto con sola guarnizione saliscendi sotto porta.
D3 - Base level 35 db achieved only with draught excluder.

E2 - Livello medio **38 db** ottenuto con guarnizione saliscendi sotto porta + materiale isolante interno
D4 - Mid level 38 db achieved with draught excluder + insulating material inside

E3 - Livello alto **40 db** ottenuto con guarnizione saliscendi sotto porta + materiale isolante interno
“special plus”
D5 - High level 40 db achieved with draught excluder + insulating material inside



CONTROPIASTRINO ELETTRICO MAGNETICO

MAGNETIC ELECTRIC STRIKE PLATE

H22 - posizionato sul montante telaio porta lato maniglia, predisposto per essere collegato ad un dispositivo elettronico per lo sblocco dello scrocco maniglia.
H22 - Positioned on the door frame upper on the handle side for connection to an electronic device for releasing the handle latch.

* Per serratura yale sic STD magnetica _ For STD magnetic Yale sic lock

H23 - posizionato sul montante telaio porta lato maniglia, predisposto per essere collegato ad un dispositivo elettronico per lo sblocco dello scrocco maniglia
H23 - Positioned on the door frame upper on the handle side for connection to an electronic device for releasing the handle latch

* Per serratura antipanico opera XT o XT DQ. Compatibile con le serrature: OPERA REI30 OPERA REI30 DQ

*For XT or XT DQ opera hotel panic lock. Compatible with locks: OPERA REI30 OPERA REI30 DQ



Poema REI 30_

1 |

VERSIONE
CON
FINITURA
LEGNO
WOOD
FINISH
VERSION

2 |

VERSIONE
IN
LAMINATO
LAMINATE
VERSION

3 |

VERSIONE
LACCATA
LACQUERED
VERSION

4 |

RESISTENZA
AL FUOCO
30 MINUTI
FIRE
RESISTANCE
30 MINUTES

5 |

PORTA
SINGOLA
SINGLE
DOOR

6 |

FONO
ISOLAMENTO
32 db
39 db
SOUND
INSULATION
32 db
39 db

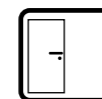

CARATTERISTICHE E PRESTAZIONI:

Porta resistente al fuoco in legno ad un'anta avente classificazione EI 30 - REI 30. Telaio maestro sp. 35 mm. Mostre telescopiche regolabili solo sul lato a tirare della porta. Guarnizione acustica fumi freddi estrusa. Guarnizione intumescente autoadesiva. Montaggio consentito su pareti in muratura o cartongesso da sp. mm. 100 minimo con resistenza al fuoco EI 30 - REI 30. Anta sp. 45 mm, complanare lato a spingere. Guarnizioni intumescenti sui bordi dell'anta.

CHARACTERISTICS AND PERFORMANCE:

Wooden - single leaf fire resistant door with EI 30 performance. Main frame 35 mm thick. Adjustable telescopic trims, only on the pull-side door. Extruded cold smoke seal for sound insulation. Intumescent autoadhesive seal. Installation allowed on gypsum board or masonry walls with minimum thickness of 100 mm and EI 30 fire resistance. Leaf thickness 45 mm, flush to frame on push side. High performance insulation core. Intumescent seals on door edges.





POEMA REI 30 ROVERE ICE.
POEMA REI 30, ICE OAK FINISH.

Poema REI 30_



VERSIONE CON FINITURA LEGNO
WOOD FINISH VERSION

ESSENZE DISPONIBILI
(rovere venatura orizzontale)
AVAILABLE FINISHES
(oak with horizontal finish)

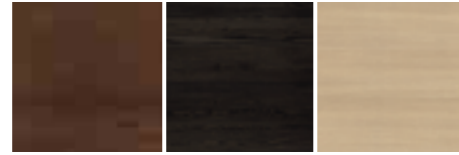

ROVERE TABACCO
TOBACCO OAK

ROVERE GRIGIO
GREY OAK

ROVERE SBIANCATO
BLEACHED OAK

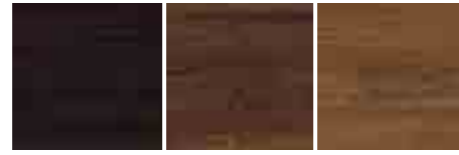

ROVERE WENGÈ
WENGÈ OAK

ROVERE CASTAGNO
CHESTNUT OAK

ROVERE TEAK
TEAK OAK



ROVERE PIETRA
STONE OAK

ROVERE GRIGIO CRETA
CLAY GREY OAK

ROVERE TERRA
EARTH OAK



ROVERE SETA
SILK OAK

ROVERE ICE
ICE OAK

COLORI DISPONIBILI
(solo venatura orizzontale)
AVAILABLE FINISHES
(only for horizontal wood grain)



ROVERE LACCATO BIANCO
A PORO APERTO
WHITE
LACQUERED
OAK OPEN-PORE

ROVERE LACCATO RAL 9010
A PORO APERTO
OAK LACQUERED
RAL 9010 OPEN-
PORE



ROVERE LACCATO AVORIO
A PORO APERTO
IVORY
LACQUERED
OAK OPEN-PORE

ROVERE LACCATO RAL 9001
A PORO APERTO
OAK LACQUERED
RAL 9001 OPEN-
PORE



ROVERE LACCATO TORTORA
A PORO APERTO
DOVE GRAY
LACQUERED
OAK OPEN-
PORE

ROVERE LACCATO RAL 7035
A PORO APERTO
OAK LACQUERED
RAL 7035 OPEN-
PORE

MODELLI DISPONIBILI
AVAILABLE MODELS

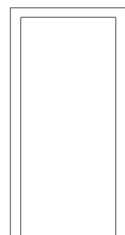

MOD. 1L

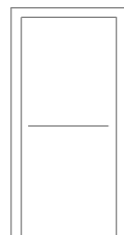

MOD. 1F

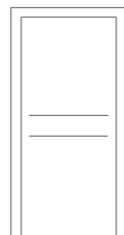

MOD. 2F

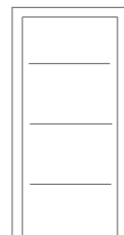

MOD. 3F



MOD. 5F

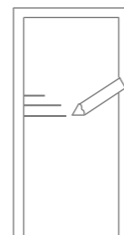

PANTOGRAFATURE
MOD. MIRAQUADRA
MIRABILIA, SUBLIMIA,
PANGEA.

PANTOGRAPHED
MODELS AVAILABLE:
MOD. MIRAQUADRA
MIRABILIA, SUBLIMIA,
PANGEA.



VERSIONE IN LAMINATO
LAMINATE VERSION.

ESSENZE DISPONIBILI
AVAILABLE FINISHES

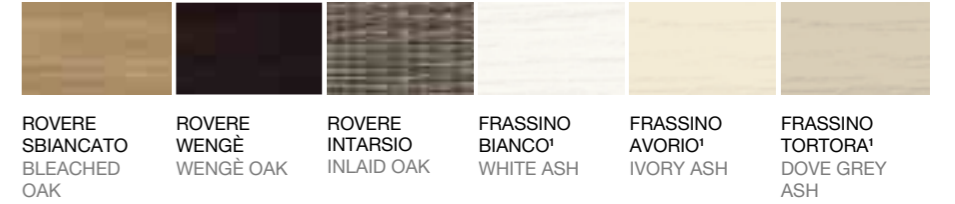

ROVERE SBIANCATO
BLEACHED
OAK

ROVERE WENGÈ
WENGÈ OAK

ROVERE INTARSIO
INLAID OAK

FRASSINO BIANCO
WHITE ASH

FRASSINO AVORIO
IVORY ASH

FRASSINO TORTORA
DOVE GREY
ASH



QUERCIA BIANCO
QUERCIA
WHITE

QUERCIA GESSO
QUERCIA OFF-
WHITE

QUERCIA SBIANCATO
QUERCIA
BLEACHED

QUERCIA BIONDO
QUERCIA
BLONDE

QUERCIA GRIGIO
QUERCIA
GREY

QUERCIA DECAPÈ
QUERCIA
PICKLED

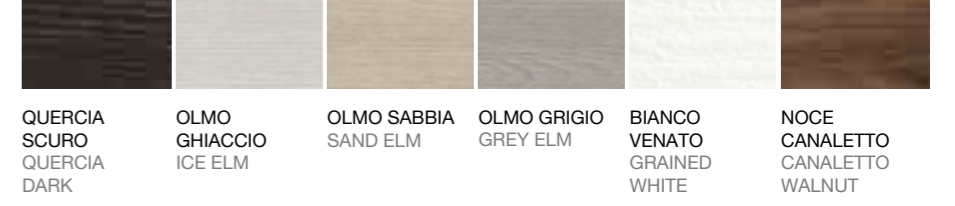

QUERCIA SCURO
QUERCIA
DARK

OLMO GHIACCIO
ICE ELM

OLMO SABBIA
SAND ELM

OLMO GRIGIO
GREY ELM

BIANCO VENATO
GRAINED
WHITE

NOCE CANALETTO
CANALETTO
WALNUT



MALTA BIANCO
WHITE
CEMENT

MALTA NUVOLA
CLOUD
CEMENT

MALTA CEMENTO
PURE CEMENT

MALTA TECHNO
TECHNO
CEMENT

MALTA GRIGIO
GREY CEMENT

MALTA CORTEN
WHITE
CORTEN

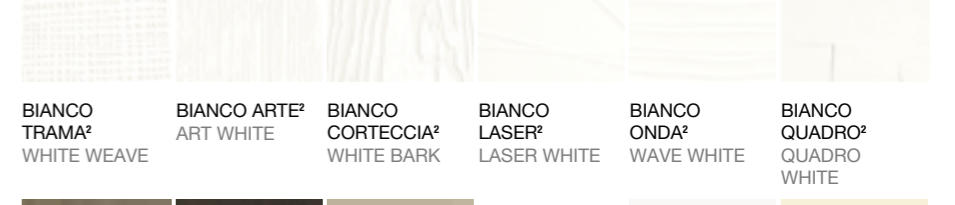

BIANCO TRAMA
WHITE WEAVE

BIANCO ARTE
ART WHITE

BIANCO CORTECCIA
WHITE BARK

BIANCO LASER
LASER WHITE

BIANCO ONDA
WAVE WHITE

BIANCO QUADRO
QUADRO
WHITE

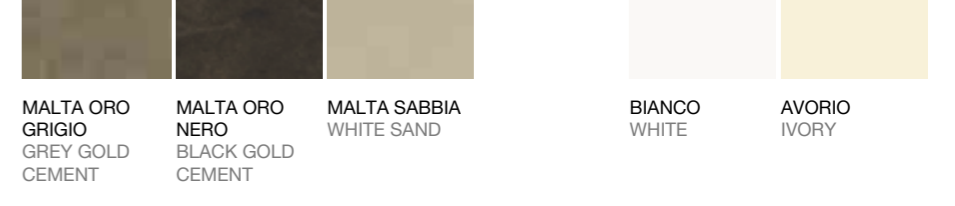

MALTA ORO GRIGIO
GREY GOLD
CEMENT

MALTA ORO NERO
BLACK GOLD
CEMENT

MALTA SABBIA
WHITE SAND

BIANCO
WHITE

AVORIO
IVORY

MODELLI DISPONIBILI
AVAILABLE MODELS



MOD. 1L



MOD. 1F

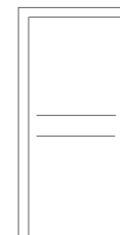

MOD. 2F



MOD. 3F



MOD. 5F

1. TELAIO E MOSTRINE LISCE
NON TEXTURIZZATI
NON-TEXTURED, SMOOTH
FRAME AND JAMBS

2. TELAIO E MOSTRINE
BIANCO LISCIO
WHITE SMOOTH FRAME
AND JAMBS

Poema REI 30_



VERSIONE LACCATA
LACQUERED VERSION

COLORI DISPONIBILI
COLOURS AVAILABLE



BIANCO
WHITE AVORIO
IVORY TORTORA
DOVE GREY

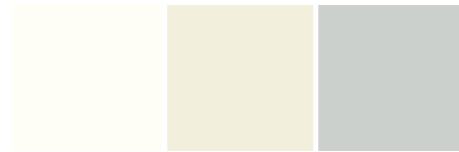

RAL 9010 RAL 9001 RAL 7035



MODELLI DISPONIBILI
AVAILABLE MODELS

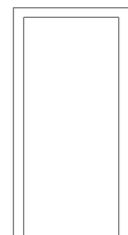

MOD. 1L

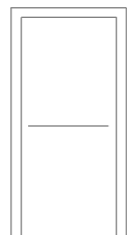

MOD. 1F

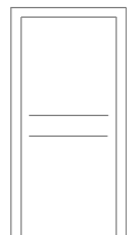

MOD. 2F

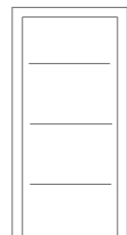

MOD. 3F



MOD. 5F

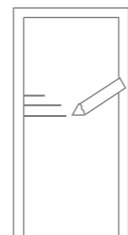

PANTOGRAFATURE
MOD. MIRAQUADRA
MIRABILIA, SUBLIMIA,
PANGEA.

PANTOGRAPHED
MODELS AVAILABLE:
MOD. MIRAQUADRA
MIRABILIA, SUBLIMIA,
PANGEA.

ELEMENTI DI SERIE PER MODELLO POEMA REI 30 STANDARD ELEMENTS FOR MODEL POEMA REI 30

Serratura tipo yale SIC con cilindro chiave - chiave.
Cerniere tipo a scomparsa. Chiudiporta a catena in-
cassato a scomparsa.

Yale SIC lock with key-key cylinder. Hidden hinges.
Spring door closer.

Questa configurazione è di SERIE per la certifica-
zione UNI 1634-1, per le altre certificazioni potrebbe
subire cambiamenti.

This configuration is valid for the "UNI 1634-1" cer-
tification. For other certifications, the standard con-
figuration may vary.



A Lato con cerniere a scomparsa.
Concealed hinges.



B Tipo yale SIC magnetica
con cilindro chiave - chiave.
Yale magnetic SIC lock with
key-key cylinder.



Fornitura standard
3 chiavi
3 keys standard
providing

C Chiudiporta a scomparsa con
molla autochiudente.
Concealed door closure with
self-closing spring.



D Mostrine lisce piatte da 88 mm sul lato
esterno (spingere porta).
Mostrine lisce piatte da 88 mm telescopiche
sul lato interno (tirare porta).
Smooth flat trims size 88 mm on the exterior
(push door).
Smooth flat trims size 88 mm telescopic on
the interior (pull door).

E Telaio. Frame.

Le porte REI 30 certificate sono realizzabili
esclusivamente nella versione a battente, ad
un'anta e senza sopra-luce.

REI 30 certified doors are only available in the
hinged door version, with single door and wi-
thout transom light.

Accessori Accessories

CHIUDIPIORTA SOLO PER VERSIONI A" T" (sistemi di chiusura optional a richiesta con supplemento)

DOOR CLOSURE SYSTEM FOR "T" - VERSIONS ONLY (optional closer systems on request with surcharge)

D1 - Chiudiporta a scomparsa incassato (apertura max 120°)
D1 - Recessed concealed door closer (max opening 120°)



KIT FONOIOLANZA

(abbattimento acustico) valido esclusivamente per porta in versione singola.

SOUND INSULATION KIT

(sound dampening) valid exclusively for single version door.

D1 - Livello base **32 db** ottenuto con guarnizione saliscendi sotto porta + materiale isolante interno + mastice sigillante.

D1 - Base level 32 dB achieved with drop seal under the door + internal insulating material + sealing putty.

D2 - Livello alto **39 db** ottenuto con guarnizione saliscendi sotto porta + materiale isolante interno special + mastice sigillante.

D2 - High level 39 dB achieved with drop seal under the door + special internal insulating material + sealing putty.

CONTROPIASTRINO ELETTRICO MAGNETICO

MAGNETIC ELECTRIC STRIKE PLATE

H22 - posizionato sul montante telaio porta lato maniglia, predisposto per essere collegato ad un dispositivo elettronico per lo sblocco dello scrocco maniglia.

H22 - Positioned on the door frame upper on the handle side for connection to an electronic device for releasing the handle latch.

* Per serratura yale sic STD magnetica _ For STD magnetic Yale sic lock

H23 - posizionato sul montante telaio porta lato maniglia, predisposto per essere collegato ad un dispositivo elettronico per lo sblocco dello scrocco maniglia

H23 - Positioned on the door frame upper on the handle side for connection to an electronic device for releasing the handle latch

* Per serratura antipanico Opera XT o XT DQ

*For Opera XT or XT DQ panic lock.



Sezione Poema 30_

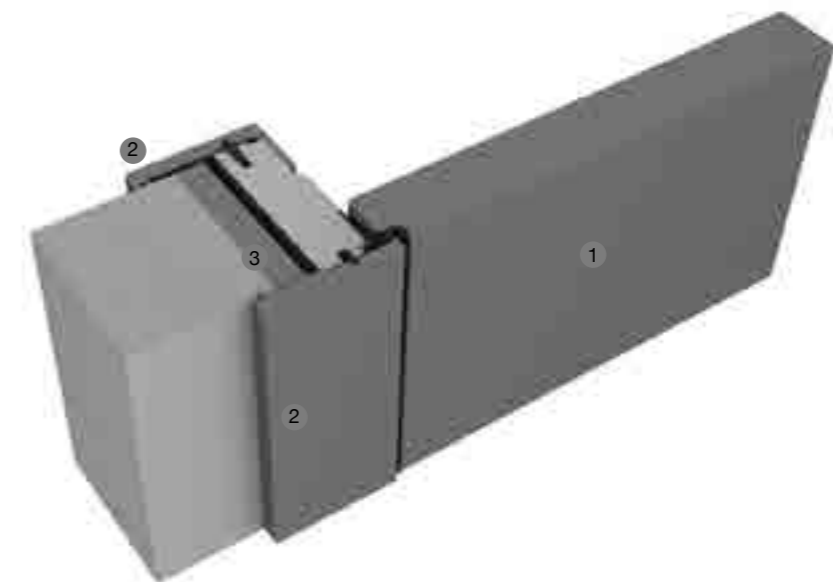
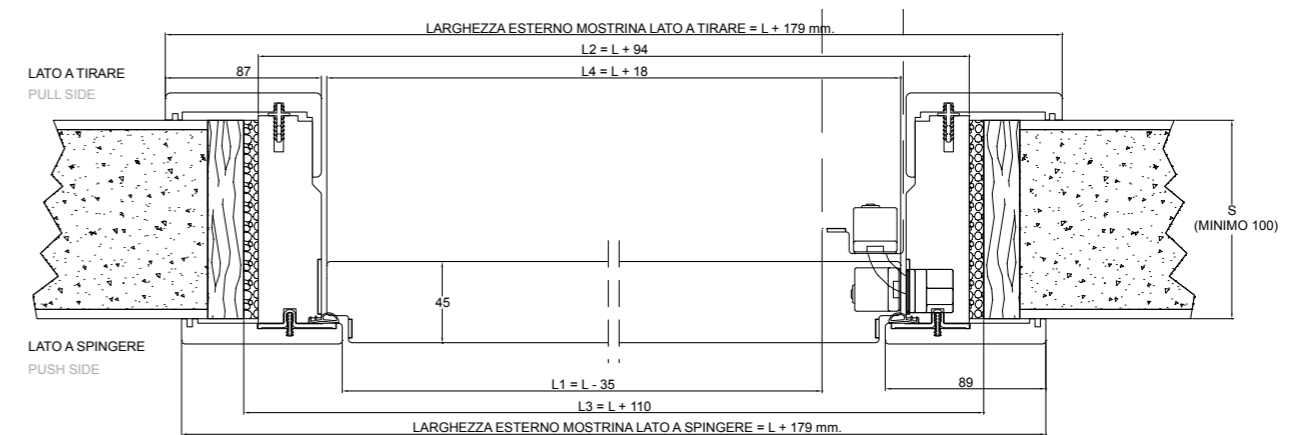

1_ANTA.DOOR.

2_MOSTRINE.TRIM.

3_TELAIO.FRAME.

Plania REI 60_

- | | | | | |
|--|--|--|--|---|
| <p>1
VERSIONE
CON
FINITURA
LEGNO
WOOD
FINISH
VERSION.</p> | <p>2
VERSIONE
LACCATA.
LACQUERED
VERSION.</p> | <p>3
RESISTENZA
AL FUOCO
60 MINUTI.
FIRE
RESISTANCE
60 MINUTES.</p> | <p>4
PORTA
SINGOLA.
SINGLE
DOOR*.</p> | <p>5
FONO
ISOLAMENTO
31 db
34 db
43 db
SOUND
INSULATION
31 db
34 db
43 db</p> |
|--|--|--|--|---|

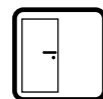

CARATTERISTICHE E PRESTAZIONI:

Porta resistente al fuoco in legno ad un'anta avente classificazione EI 60 - REI 60. Telaio sp. 55 mm. Mostrine telescopiche regolabili nel lato a tirare piatte da 120 mm. sul lato a spingere. Guarnizione acustica fumi freddi estrusa. Guarnizione intumescente autoadesiva. Montaggio consentito su pareti in muratura o cartongesso da sp. mm 100 minimo con resistenza al fuoco EI 60 - REI 60. Anta sp. 63 mm, complanare alle mostrine lato a spingere.

CHARACTERISTICS AND PERFORMANCE:

Wooden - single leaf fire resistant door with EI60 performance. Master frame 55 mm. Telescopic trims adjustable in the pull side and flat 120 mm on the push side. Acoustic seal extruded cold smoke. Intumescent gasket adhesive. Installation allowed on masonry walls or gypsum board with thickness mm 100 minimum fire resistance EI60. 63 mm thickness door, flush with trims on the push side.





457

Plania REI 60_



PLANIA REI 60 IN VERSIONE
LEGNO ROVERE TEAK.

PLANIA REI 60 IN TEAK OAK
VERSION.

Plania REI 60

PLANIA REI 60 ROVERE LACCATO
BIANCO A PORO APERTO.

PLANIA REI 60 WHITE LACQUERED
OAK OPEN-PORE.



Plania REI 60

PLANIA REI 60 LACCATO
BIANCO LUCIDO.

PLANIA REI 60 GLOSS WHITE
LACQUER.



Plania REI 60_



VERSIONE CON FINITURA LEGNO
WOOD FINISH VERSION

ESSENZE DISPONIBILI
(rovere venatura orizzontale)
AVAILABLE FINISHES
(oak with horizontal finish)

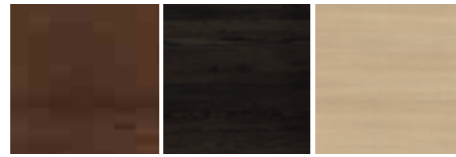

ROVERE
TABACCO
TOBACCO OAK

ROVERE
GRIGIO
GREY OAK

ROVERE
SBIANCATO
BLEACHED OAK

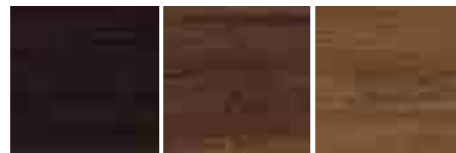

ROVERE
WENGÈ
WENGÈ OAK

ROVERE
CASTAGNO
CHESTNUT OAK

ROVERE
TEAK
TEAK OAK

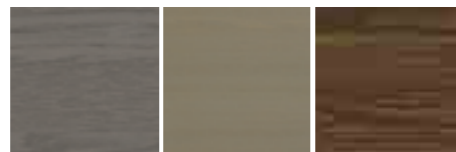

ROVERE
PIETRA
STONE OAK

ROVERE
GRIGIO CRETA
CLAY GREY OAK

ROVERE
TERRA
EARTH OAK



ROVERE
SETA
SILK OAK

ROVERE
ICE
ICE OAK

COLORI DISPONIBILI
(solo venatura orizzontale)
AVAILABLE FINISHES
(only for horizontal wood grain)



ROVERE
LACCATO
BIANCO
A PORO APERTO
WHITE
LACQUERED
OAK OPEN-PORE

ROVERE
LACCATO RAL
9010
A PORO APERTO
OAK LACQUERED
RAL 9010 OPEN-
PORE

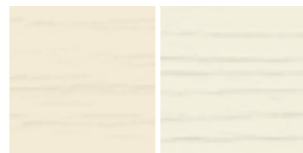

ROVERE
LACCATO
AVORIO
A PORO APERTO
IVORY
LACQUERED
OAK OPEN-PORE

ROVERE
LACCATO RAL
9001
A PORO APERTO
OAK LACQUERED
RAL 9001 OPEN-
PORE

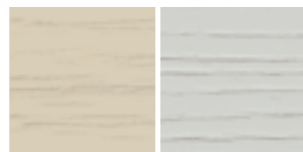

ROVERE
LACCATO
TORTORA
A PORO
APERTO
DOVE GRAY
LACQUERED
OAK OPEN-
PORE

ROVERE
LACCATO RAL
7035
A PORO APERTO
OAK LACQUERED
RAL 7035 OPEN-
PORE

MODELLI DISPONIBILI
AVAILABLE MODELS

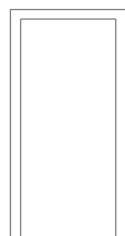

MOD. 1L

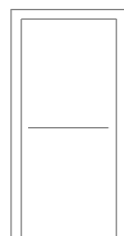

MOD. 1F

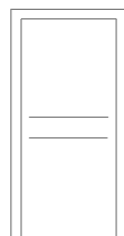

MOD. 2F

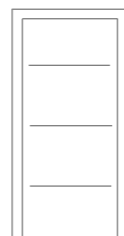

MOD. 3F



MOD. 5F

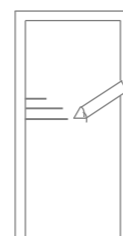

PANTOGRAFATURE
MOD. MIRAQUADRA
MIRABILIA, SUBLIMIA,
PANGEA.

PANTOGRAPHED
MODELS AVAILABLE:
MOD. MIRAQUADRA
MIRABILIA, SUBLIMIA,
PANGEA.

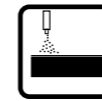

VERSIONE LACCATA.
LACQUERED VERSION.

COLORI DISPONIBILI
COLOURS AVAILABLE



BIANCO
WHITE

AVORIO
IVORY

TORTORA
DOVE GREY

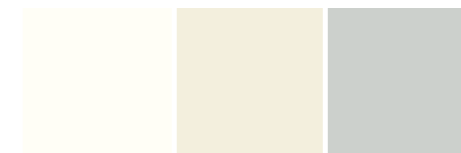

RAL 9010

RAL 9001

RAL 7035



COLORI RAL A RICHIESTA PER STILIA30. RAL COLOURS, UPON REQUEST.



MODELLI DISPONIBILI
AVAILABLE MODELS

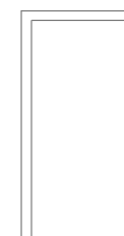

MOD. 1L

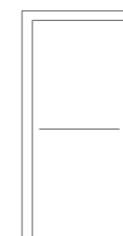

MOD. 1F



MOD. 2F

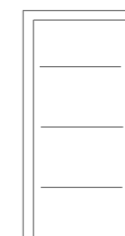

MOD. 3F



MOD. 5F

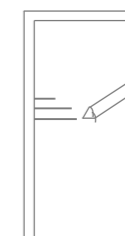

PANTOGRAFATURE
MOD. MIRAQUADRA
MIRABILIA, SUBLIMIA,
PANGEA, DORÉ.

PANTOGRAPHED
MODELS AVAILABLE:
MOD. MIRAQUADRA
MIRABILIA, SUBLIMIA,
PANGEA, DORÉ.

Plania REI 60_

ELEMENTI DI SERIE PER MODELLO PLANIA REI 60 STANDARD ELEMENTS FOR MODEL PLANIA REI 60

Serratura tipo yale SIC con cilindro chiave - chiave. Cerniere anuba con autochiudenti integrata. Rostri metallici di tenuta con guarnizioni intumescenti.
Yale SIC lock with key-key cylinder. Anuba integrated self-closing hinges. Metal nib sealing elements with intumescent seals.

Questa configurazione è di SERIE per la certificazione UNI 1634-1, per le altre certificazioni potrebbe subire cambiamenti.

This configuration is valid for the "UNI 1634-1" certification. For other certifications, the standard configuration may vary.



- A** Cerniere anuba regolabili autochiudenti.
Adjustable anuba hinges, bearing and self-closing.



- B** Tipo yale SIC con cilindro chiave-chiave.
Yale SIC lock with key-key cylinder.



- C** Mostrine lisce piatte da 120 mm sul lato esterno (spingere porta).
Mostrine lisce piatte da 88 mm telescopiche sul lato interno (tirare porta).
Smooth flat trims size 120 mm on the exterior (on the push side).
Smooth flat trims size 88 mm telescopic on the interior (on the pull side).

- D** Telaio. Frame.

Le porte REI 60 certificate sono realizzabili esclusivamente nella versione a battente, ad un'anta e senza sopra-luce.

REI 60 certified doors are only available in the hinged door version, with single door and without transom light.

Sezione Plania REI 60_

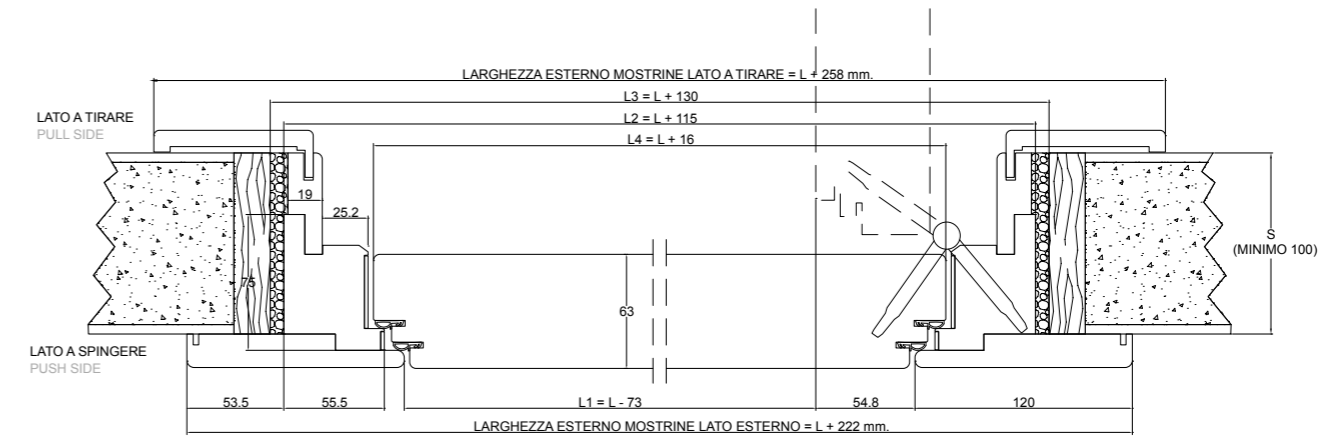

1_ANTA.DOOR.
2_MOSTRINE.TRIM.
3_TELAIO.FRAME.

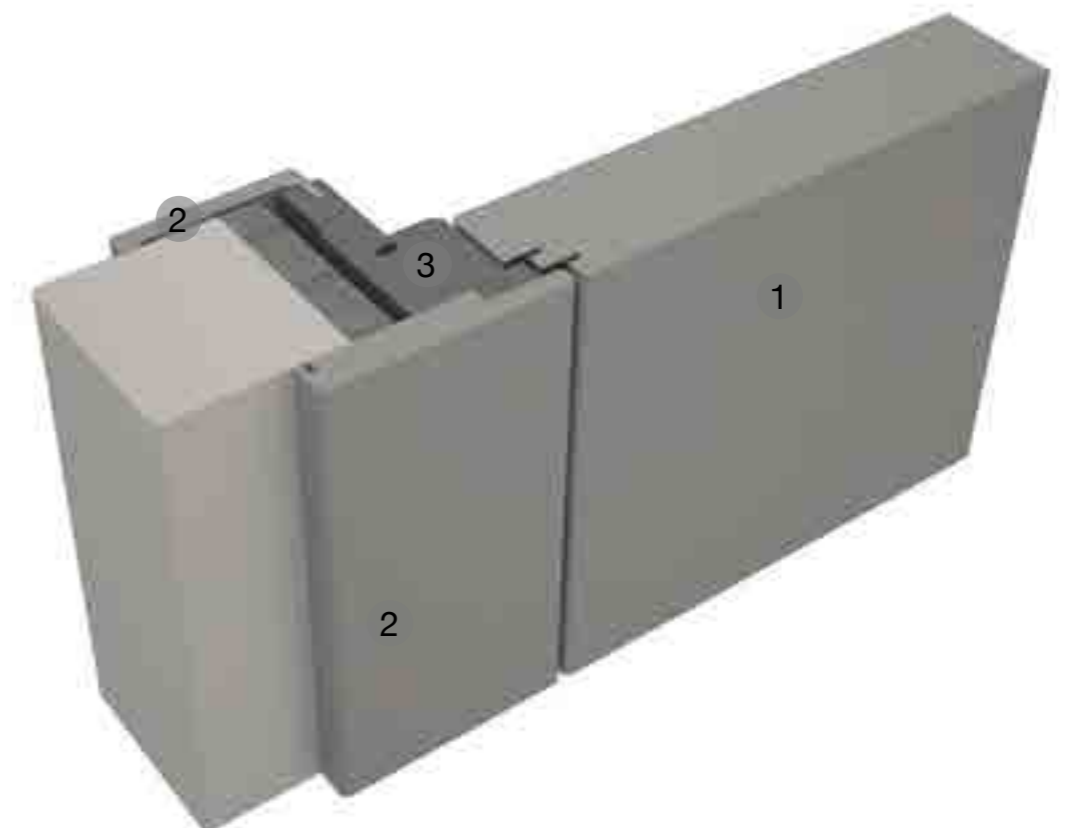

Plania REI 60_

INFORMAZIONI TECNICHE TECHNICAL DATA

CARATTERISTICHE E PRESTAZIONI:

Certificata EI60 secondo UNI EN1634-1:2009. Prodotto omologato come da art.1 del D.M. 30/06/2004 dal Ministero dell'Interno con atto di omologazione AN170EI2060P011/AN170EI1060P010.

CHARACTERISTICS AND PERFORMANCE:

EI60 certification in accordance with UNI EN1634-1:2009. Product type-approved in accordance with art.1 of M.D. of 30/06/2004 issued by the Ministry of the Interior with type approval act AN170EI2060P011/AN170EI1060P010.

FONOSOLANZA

Nessun pacchetto acustico incluso di serie

SOUND INSULATION

Sound insulation is not included as standard

SISTEMI DI CHIUSURA OPTIONAL (a richiesta con supplemento) OPTIONAL CLOSER SYSTEMS (on request with surcharge)

C1 - Cerniere tipo a scomparsa regolabile.
C1 - Adjustable hidden hinges.

C2 - Chiudiporta a catena incassato a scomparsa (1° opzione in abbinamento alle cerniere a scomparsa).
C2 - Spring door closer (option 1 in combination with adjustable hidden hinges).

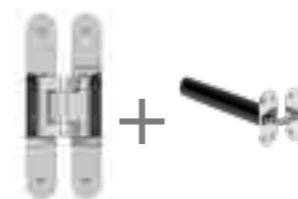

Accessori Accessories

CHIUDIPIORTA (abbinabili sia con cerniere a pomella, che a scomparsa)
DOOR CLOSER SYSTEMS (can be combined with both knob lock and hidden hinges)

C2 - Chiudiporta a scomparsa incassato (apertura max 120°)
C2 - Recessed concealed door closer (max opening 120°)

C3 - Chiudiporta aereo a braccio a "V" a cremagliera regolabile per forza e velocità apertura max 170°
C3 - Overhead "V" arm door closer and rack gear with adjustable force and speed, max opening 170°

C4 - Chiudiporta aereo a braccio e con slitta SLIM regolabile per forza e velocità apertura max 150°
C4 - Overhead door closer with arm and SLIM slide with adjustable force and speed, max opening 150°

C4A - Limitatore di apertura per chiudiporta aereo a braccio a slitta.
C4A - Opening limiter for overhead door closer with sliding arm.

KIT FONOSOLANZA

(abbattimento acustico) valido esclusivamente per porta in versione singola.

SOUND INSULATION KIT

(sound insulation) valid exclusively for single version door.

D1 - Livello base 31dB ottenuto con sola guarnizione saliscendi sotto porta.
D1 - 31dB Base level achieved solely with sliding seal below door.

D2 - Livello medio 34dB ottenuto con guarnizione saliscendi sotto porta + materiale isolante interno + mastice sigillante.
D2 - 34dB Mid level achieved with draught excluder + insulating material inside + sealing mastic.

D3 - Livello alto 43dB ottenuto con guarnizione saliscendi sotto porta + materiale isolante interno "special".
D3 - 34dB Mid level achieved with draught excluder + insulating material inside "special".

CONTROPIASTRINI ELETTRICO MAGNETICO

MAGNETIC ELECTRIC STRIKE PLATE

H20 - posizionato sul montante telaio porta lato maniglia, predisposto per essere collegato ad un dispositivo elettronico per lo sblocco dello scrocco maniglia.

H20 - Positioned on the door frame upper on the handle side for connection to an electronic device for releasing the handle latch.

Per serrature optional, supplementi per mostrine di larghezza maggiorata, maggiorazioni per misure non standard consultare il listino prezzi.

For optional locks, surcharges for oversized width trims, surcharges for non-standard sizes, consult the price list.



Gdesign REI 60_

- | | | | | | | | | |
|---|--|--|--------------------------------|-------------------------------|---|---|--|----------------------------|
| 1 | 2 | 3 | 4 | 5 | 6 | 7 | 8 | 9 |
| VERSIONE CON FINITURA LEGNO
WOOD FINISH VERSION. | VERSIONE LACCATA
LACQUERED VERSION. | RESISTENZA AL FUOCO 60 MINUTI
FIRE RESISTANCE 60 MINUTES. | PORTA SINGOLA.
SINGLE DOOR. | DOPPIA PORTA.
DOUBLE DOOR. | FONO ISOLAMENTO
33 db
40 db
45 db
SOUND INSULATION
33 db
40 db
45 db | OBLÒ ROTONDO
MAX 0,25 MQ.
ROUND PORTHOLE
MAX. 0.25 M2. | OBLÒ RETTANGOLARE
MAX 0,25 MQ.
RECTANGULAR PORTHOLE
MAX. 0.25 M2. | PROVA FUMI.
SMOKE TEST. |

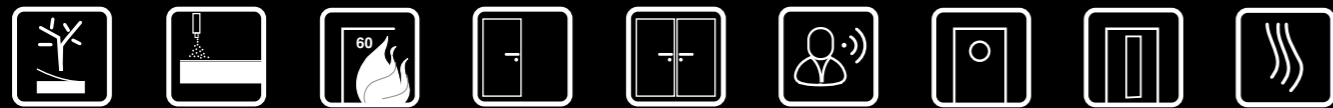

CARATTERISTICHE E PRESTAZIONI:

Porta resistente al fuoco in legno ad un'anta avente classificazione EI 60 - REI 60. Telaio sp. 60 mm. Mostre telescopiche regolabili. Guarnizione acustica fumi freddi estrusa. Guarnizione intumescente autoadesiva. Montaggio consentito su pareti in muratura o cartongesso da sp. mm. 100 minimo con resistenza al fuoco EI 60 - REI 60. Anta sp. 60 mm, complanare lato a tirare al telaio e mostrine.

CHARACTERISTICS AND PERFORMANCE:

Wooden - single leaf fire resistant door with EI 60 performance. Main frame 60 mm thick. Adjustable telescopic covering profiles. Extruded cold smoke seal. Intumescent autoadhesive seal. Installation allowed on gypsum board or masonry walls with minimum thickness of 100 mm and EI 60 fire resistance. Leaf 60 mm thick, flush to frame on pull side.



GDESIGN REI 60 LACCATO BIANCO
PANTOGRAFATURA MODELLO
MIRAQUADRA 3B.

GDESIGN REI 60 WHITE LACQUERED
PANTOGRAPHED MODEL
MIRAQUADRA 3B.

Gdesign REI 60_

GDESIGN REI 60,
FINITURA BIANCO LACCATO,
PANTOGRAFATURA MODELLO
MIRABILIA 6B.

GDESIGN REI 60,
WHITE LACQUERED FINISH,
MIRABILIA 6B MODEL.



Gdesign REI 60_

GDESIGN REI 60 IN ROVERE
NATURALE MODELLO 2F CON
FILETTI METALLICI CROMO
SATINATO.

GDESIGN REI 60, NATURAL OAK
FINISH, 2F MODEL WITH SATIN
CHROME METAL STRIPS.

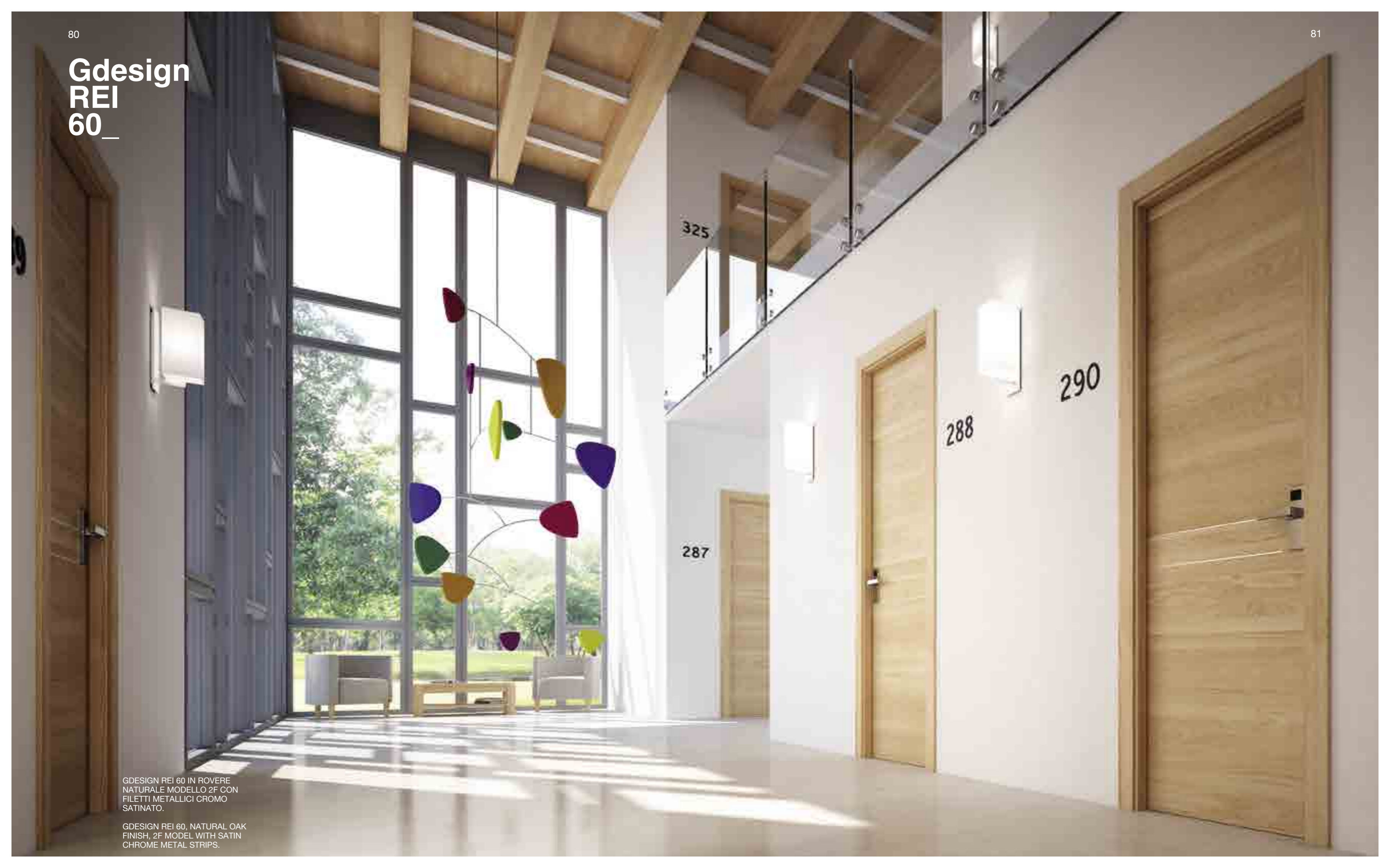

Gdesign REI 60_



VERSIONE CON FINITURA LEGNO
WOOD FINISH VERSION.

ESSENZE DISPONIBILI
(rovere venatura orizzontale)
AVAILABLE FINISHES
(oak with horizontal finish)

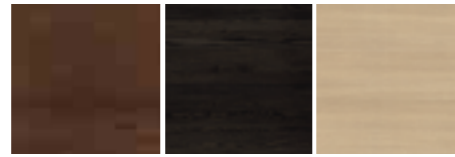

ROVERE
TABACCO
TOBACCO OAK

ROVERE
GRIGIO
GREY OAK

ROVERE
SBIANCATO
BLEACHED OAK

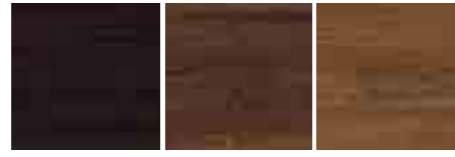

ROVERE
WENGÈ
WENGÈ OAK

ROVERE
CASTAGNO
CHESTNUT OAK

ROVERE
TEAK
TEAK OAK

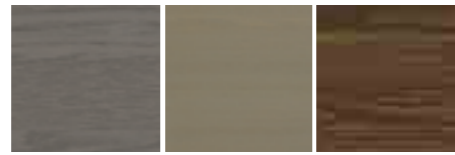

ROVERE
PIETRA
STONE OAK

ROVERE
GRIGIO CRETA
CLAY GREY OAK

ROVERE
TERRA
EARTH OAK



ROVERE
SETA
SILK OAK

ROVERE
ICE
ICE OAK

COLORI DISPONIBILI
(solo venatura orizzontale)
AVAILABLE FINISHES
(only for horizontal wood grain)



ROVERE
LACCATO
BIANCO
A PORO APERTO
WHITE
LACQUERED
OAK OPEN-PORE

ROVERE
LACCATO RAL
9010
A PORO APERTO
OAK LACQUERED
RAL 9010 OPEN-
PORE

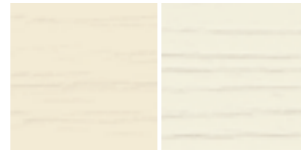

ROVERE
LACCATO
AVORIO
A PORO APERTO
IVORY
LACQUERED
OAK OPEN-PORE

ROVERE
LACCATO RAL
9001
A PORO APERTO
OAK LACQUERED
RAL 9001 OPEN-
PORE



ROVERE
LACCATO
TORTORA
A PORO
APERTO
DOVE GRAY
LACQUERED
OAK OPEN-
PORE

ROVERE
LACCATO RAL
7035
A PORO APERTO
OAK LACQUERED
RAL 7035 OPEN-
PORE



MODELLI DISPONIBILI
AVAILABLE MODELS

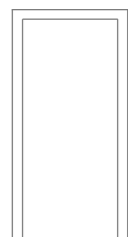

MOD. 1L

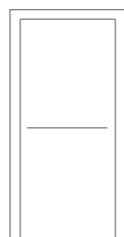

MOD. 1F

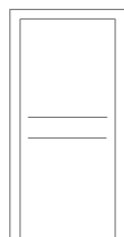

MOD. 2F

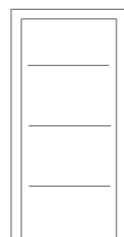

MOD. 3F



MOD. 5F

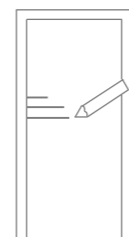

PANTOGRAFATURE
MODELLI:
MIRAWOOD, MIRAQUADRA, MIRABILIA, PANGEA
(solo su legno rovere laccato a poro aperto)

PANTOGRAPHED
MODELS AVAILABLE:
MIRAWOOD, MIRAQUADRA, MIRABILIA, PANGEA
(only available for lacquered oak open-pore)



VERSIONE LACCATA
LACQUERED VERSION

COLORI DISPONIBILI
COLOURS AVAILABLE



BIANCO
WHITE

AVORIO
IVORY

TORTORA
DOVE GREY

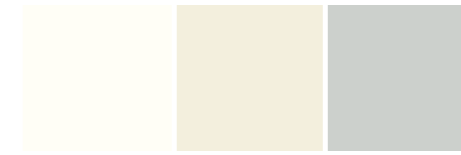

RAL 9010

RAL 9001

RAL 7035



COLORI RAL A RICHIESTA PER STILIA30. RAL COLOURS, UPON REQUEST.

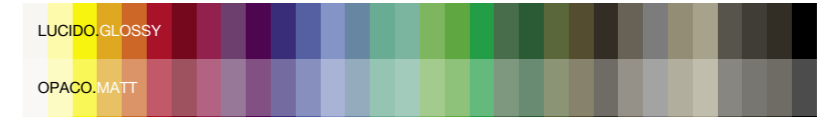

MODELLI DISPONIBILI
AVAILABLE MODELS

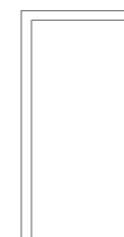

MOD. 1L



MOD. 1F



MOD. 2F

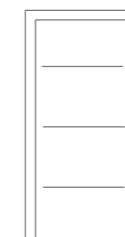

MOD. 3F



MOD. 5F

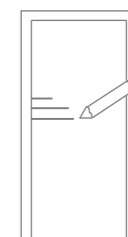

PANTOGRAFATURE
MODELLI:
MIRAQUADRA
MIRABILIA
SUBLIMIA
PANGEA

PANTOGRAPHED
MODELS AVAILABLE:
MIRAQUADRA
MIRABILIA
SUBLIMIA
PANGEA

Gdesign REI 60_

ELEMENTI DI SERIE PER MODELLO GDESIGN REI 60 A BATTENTE SINGOLA STANDARD ELEMENTS for model GDESIGN REI 60 SINGLE HINGED DOOR

Serratura tipo yale SIC con cilindro chiave-chiave in finitura a scelta ottone lucido o cromo satinato. Cerniere tipo a scomparsa. braccio chiudiporta a slitta.

Yale SIC lock with key-key cylinder in polished brass or satin chrome finish. concealed hinges. door closing arm with slide.

Questa configurazione è di SERIE per la certificazione UNI 1634-1, per le altre certificazioni potrebbe subire cambiamenti.

This configuration is valid for the "UNI 1634-1" certification. For other certifications, the standard configuration may vary.



- A** Lato cerniere tipo a scomparsa.
Concealed hinges.



- B** Serratura tipo yale SIC con cilindro chiave-chiave.
Yale SIC lock with key-key cylinder.



Fornitura standard
3 chiavi
3 keys standard
providing

- C** Chiudiporta aereo a braccio a slitta.
Overhead door closing arm with slide.



- D** Mostrine lisce piatte da 88 mm sia sul lato esterno (spingere porta) sia sul lato interno (tirare porta).
Smooth flat trims size 88 mm on both sides of the door.

- E** Telaio.
Frame.

Gdesign REI 60_

ELEMENTI DI SERIE PER MODELLO GDESIGN REI 60 A BATTENTE DOPPIA GDESIGN REI 60 DOUBLE HINGED DOOR

Serratura tipo yale SIC con cilindro chiave-chiave. Contro-serratura + ferramenta per anta secondaria. Cerniere tipo a scomparsa. Braccio chiudiporta a slitta. Sequenziatore chiusura ante.

Yale SIC lock with key-key cylinder. Lock striker + hardware for second door. Concealed hinges. Door closing arm with slide. Door closure sequencer.

Questa configurazione è di SERIE per la certificazione UNI 1634-1, per le altre certificazioni potrebbe subire cambiamenti.

This configuration is valid for the "UNI 1634-1" certification. For other certifications, the standard configuration may vary.



- A** Lato cerniere tipo a scomparsa.
Concealed hinges.



- B** Serratura Tipo yale SIC con cilindro chiave-chiave. Contro-serratura + ferramenta per anta secondaria.
Yale SIC lock with key-key cylinder. Lock striker + hardware for second door.



Fornitura standard
3 chiavi
3 keys standard
providing

- C** Chiudiporta aereo a braccio a slitta.
Overhead door closing arm with slide.



- D** Sequenziatore chiusura ante.
Door closure sequencer.



- E** Mostrina.
Trim.

- F** Telaio.
Frame.

Gdesign REI 60_

Sezione Gdesign REI 60_. Single hinged version

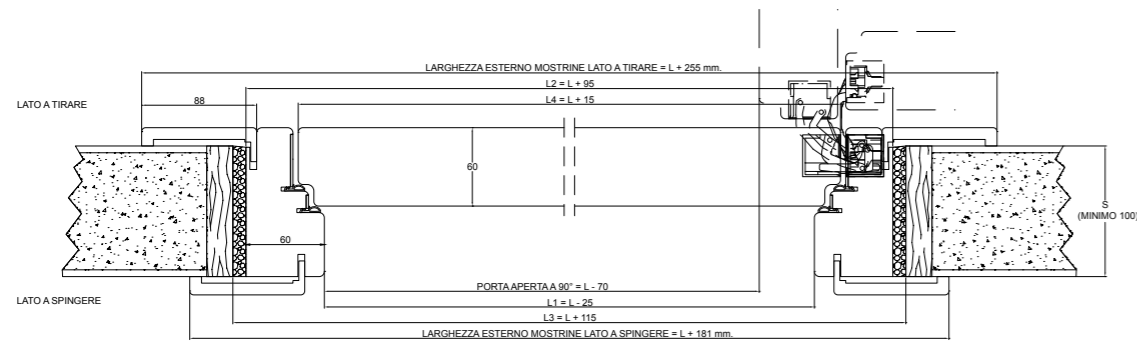

Sezione Gdesign REI 60_Doppia. Double hinged version

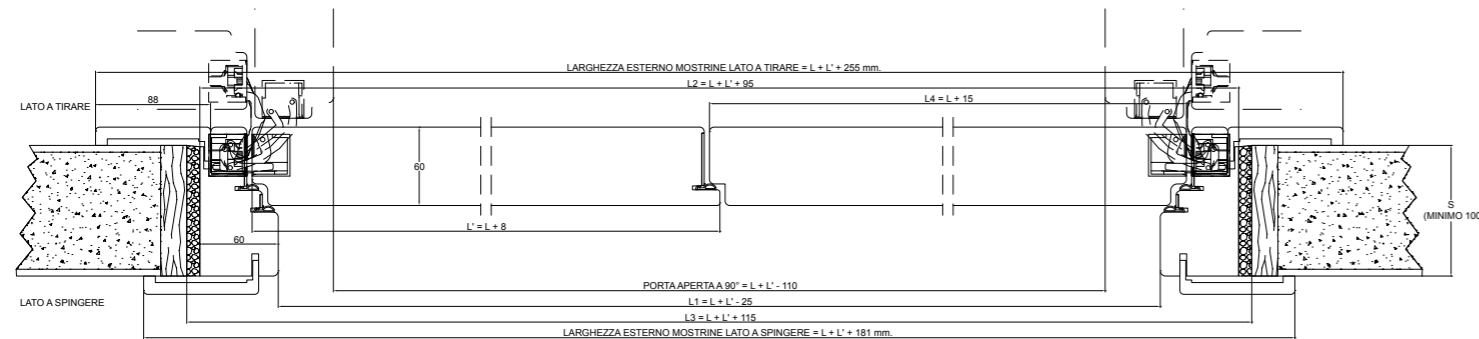

- 1_ANTA.DOOR.
- 2_MOSTRINE.TRIM.
- 3_TELAIO.FRAME.

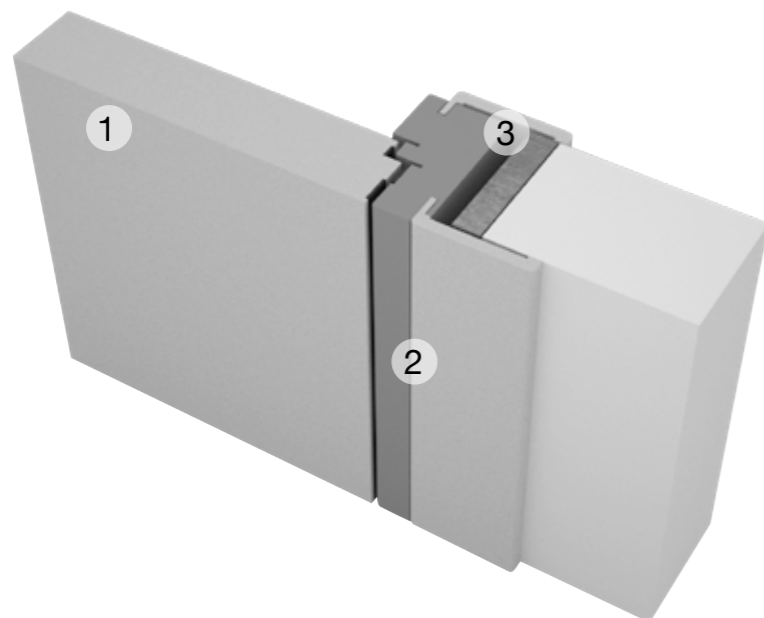

Gdesign REI 60_

INFORMAZIONI TECNICHE TECHNICAL DATA FOR MODEL GDESIGN REI 60

CARATTERISTICHE E PRESTAZIONI:
Certificata EI60 secondo UNI EN1634-1:2009. Prodotto omologato come da art.1 del D.M. 30/06/2004 dal Ministero dell'Interno con atto di omologazione AN170EI1060P007.

CHARACTERISTICS AND PERFORMANCE:
EI60 certification in accordance with UNI EN1634-1:2009. Product type-approved in accordance with art.1 of M.D. of 30/06/2004 issued by the Ministry of the Interior with type approval act AN170EI1060P007.

FONOSOLANZA

Nessun pacchetto acustico incluso di serie

SOUNDPROOFING

Sound insulation is not included as standard

Accessori

Accessories

FINITURE - SERVIZI OPTIONAL (a richiesta con supplemento)
FINISHES - OPTIONAL SERVICES (on request with surcharge)

OBLÒ A VETRO
GLASS PORTHOLE

C1 - FORMA ROTONDA (superficie max 0,25 mq) con vetro certificato EI 60 trasparente.
C1 - ROUND SHAPE (max. surface area 0.25 m2) with transparent glass EI 60 certified.

C2 - FORMA ROTONDA (superficie max 0,25 mq) con vetro certificato EI 60 sabbiato.
C2 - ROUND SHAPE (max. surface area 0.25 m2) with glass sandblasted EI 60 certified.

C3 - FORMA RETTANGOLARE O QUADRATA (superficie max 0,25 mq) con vetro certificato EI 60 trasparente.
C3 - SQUARE OR RECTANGULAR SHAPE (max. surface area 0.25 m2) with transparent glass EI 60 certified.

C4 - FORMA RETTANGOLARE O QUADRATA (superficie max 0,25 mq) con vetro certificato EI 60 sabbiato.
C4 - Rectangular or square (surface max 0.25 m) with glass sandblasted EI 60 certified.

CHIUDIPIORTA (sistemi di chiusura optional a richiesta con supplemento)
DOOR CLOSER SYSTEMS (optional closer systems on request with surcharge)

C2 - Chiudiporta a scomparsa incassato (apertura max 120°)
C2 - Recessed concealed door closer (max opening 120°)



C3 - Chiudiporta aereo a braccio a "V" a cremagliera regolabile per forza e velocità apertura max 170°
C3 - Overhead "V" arm door closer and rack gear with adjustable force and speed, max opening 170°



D3 - Chiudiporta aereo a braccio e con slitta con sequenziatore di chiusura incorporato
Apertura max 150°.
D4 - Overhead door closing arm with slide with built-in closer sequencer (for double doors).



D3A - Chiudiporta aereo a braccio e con slitta con sequenziatore di chiusura incorporato e fermaporta elettromeccanico. Apertura max 150°.
D3A - Overhead door closer with arm and slide with built-in closing sequencer and electromechanical door stop. Max opening 150°.

D4 - Chiudiporta a scomparsa ad incassato lato superiore anta e telaio (per porta doppia).
D4 - Recessed concealed door closure system on top of door and frame (for double doors).



D5 - Chiudiporta a scomparsa ad incassato lato superiore anta e telaio e sequenziatore incorporato con fermaporta elettromeccanico (per porta doppia).
D5 - Concealed door closure recessed above the door and frame and built-in sequencer with electromechanical door stop (for double door).

Nota: inserendo questo sistema, la larghezza minima realizzabile delle ante diventa: 550 mm.
Note: when using this system, the minimum possible door width becomes: 550 mm.

KIT FONOIOLANZA

(abbattimento acustico) valido esclusivamente per porta in versione singola.

SOUND INSULATION KIT

(sound insulation) valid exclusively for single version door.

E1 - Livello base 33db ottenuto con guarnizione saliscendi sotto porta.

E1 - 33db base level achieved with draught excluder.

E2 - Livello medio 40db ottenuto con guarnizione saliscendi sotto porta + materiale isolante interno + mastice sigillante.

E2 - 40db mid level achieved with draught excluder + insulating material inside + sealing mastic.

E3 - Livello alto 45db ottenuto con guarnizione saliscendi sotto porta + materiale isolante interno "special" + mastice sigillante.

E3 - E3 - 45db high level achieved with draught excluder insulating material inside + sealing mastic.



CONTROPIASTRINI ELETTRICO MAGNETICO

MAGNETIC ELECTRIC STRIKE PLATE

L20 - posizionato sul montante telaio porta lato maniglia, predisposto per essere collegato ad un dispositivo elettronico per lo sblocco dello scrocco maniglia.

L20 - Positioned on the door frame upper on the handle side for connection to an electronic device for releasing the handle latch.



Filomuro REI 60_

1	2	3	4	5	6	7
VERSIONE CON FINITURA LEGNO WOOD FINISH VERSION.	VERSIONE LACCATA. LACQUERED VERSION.	RESISTENZA AL FUOCO 60 MINUTI. FIRE RESISTANCE 60 MINUTES.	PORTA SINGOLA. SINGLE DOOR*.	OBLÒ RETTANGOLARE MAX 0,25 MQ. RECTANGULAR PORTHOLE MAX. 0.25 M2.	FONO ISOLAMENTO 28 db 38 db 42 db SOUND INSULATION 28 db 38 db 42 db	PORTA KLIMA 3(b) DOOR KLIMA 3(b)
						

CARATTERISTICHE E PRESTAZIONI:

Porta resistente al fuoco ad un'anta in legno con telaio in alluminio avente classificazione EI60 - REI 60.
Telaio estruso da inserire nella muratura o nel cartongesso con spessore da mm. 125 minimo con resistenza al fuoco EI 60 - REI 60. Anta sp. 60 mm, complanare al muro sul lato a spingere o tirare. Guarnizioni intumescenti sul telaio.

CHARACTERISTICS AND PERFORMANCE:

Fire resistant wooden door with aluminum frame having EI60 classification - REI 60.
Extruded frame to include in the brickwork or in plasterboard with mm thick. 125 with minimum fire resistance EI 60 - REI 60.
60 mm leaf which can be flush in the pull or push side. Intumescent gasket on thze frame.



Filomuro REI 60_

FILOMURO REI 60 LACCATA NERO
LUCIDO VISTA LATO ESTERNO.

FILOMURO REI 60, GLOSSY BLACK
LACQUERED, PUSH SIDE VIEW.



Filomuro REI 60

FILOMURO REI 60 ROVERE GRIGIO
LATO INTERNO.
PARQUET E MENSOLA
SCRIVANIA ROVERE GRIGIO.
ARMADIO A MURO MIRIA LACCATO
NERO LUCIDO
CON PROFILO PLANIA.
PANCA REALIZZATA
CON MENSOLE LACCATE
NERO LUCIDO.

FILOMURO REI 60, GREY OAK
FINISH, PULL SIDE VIEW. PARQUET
AND DESK SHELF: GREY OAK
FINISH. PLANIA MIRIA WARDROBE,
GLOSSY BLACK LACQUERED
FINISH. BENCH CREATED WITH
GLOSSY BLACK LACQUERED
SHELVES.

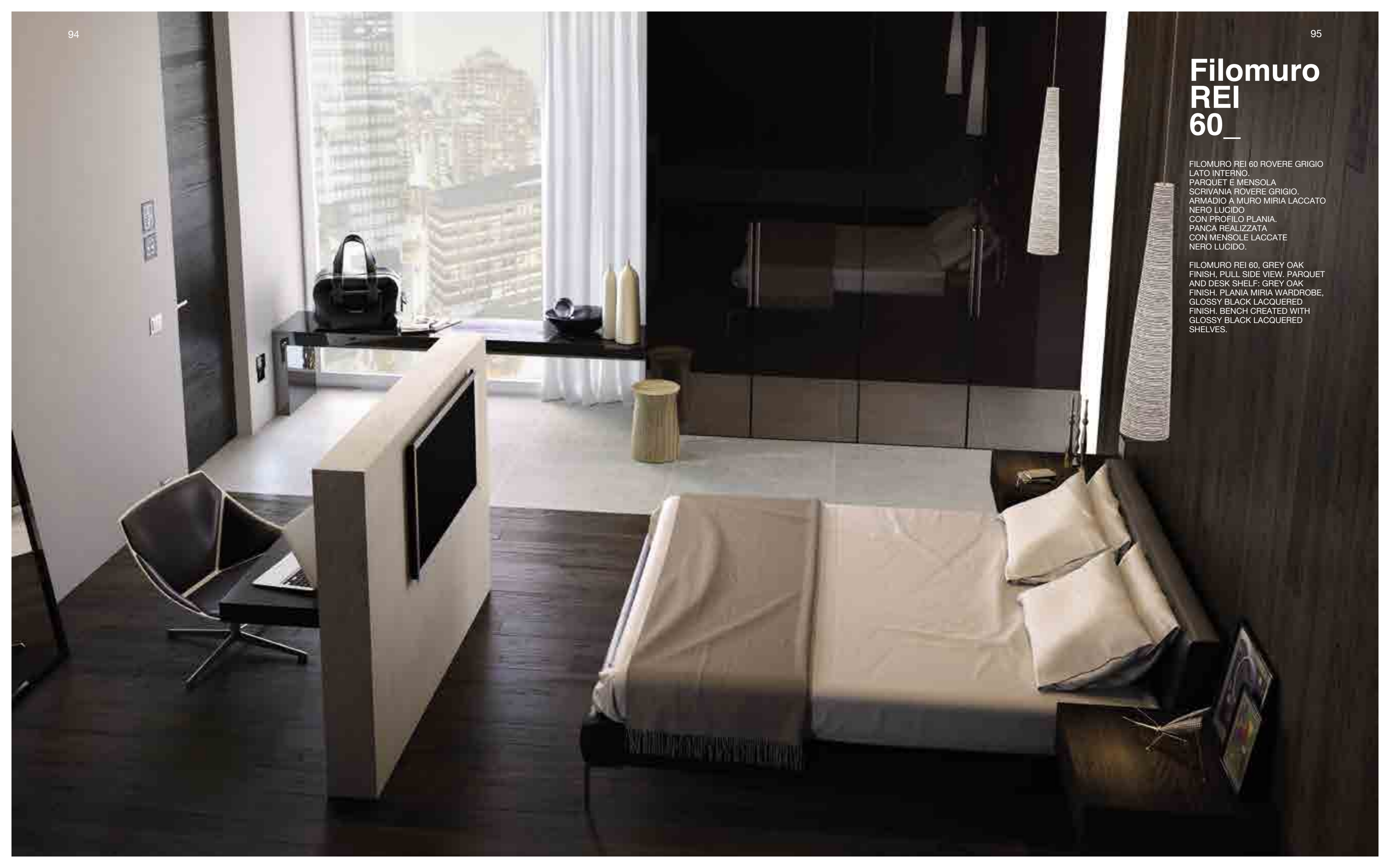

Filomuro REI 60_

VISTA INTERNA DELLA CAMERA,
DAL LATO DEL BAGNO. BOISERIE
E MENSOLE IN ROVERE GRIGIO.
ARMADIO MIRIA PLANIA,
LACCATO NERO LUCIDO.

INSIDE VIEW OF THE ROOM:
BATHROOM CORNER WITH
BOISERIE AND SHELF, GREY
OAK FINISH. MIRIA PLANIA
WARDROBE, GLOSSY BLACK
LACQUERED FINISH.



Filomuro REI 60

FILO MURO REI 60
INTONACATA CON
MALTINA CEMENTIZIA
GRIGIA.

FILOMURO REI 60,
GREY PLASTER
WALLS.



Filomuro REI 60_

UN PARTICOLARE DELLA
FILOMURO REI 60.

CLOSE-UP OF THE
FILOMURO REI 60.



Filomuro REI 60_



VERSIONE CON FINITURA LEGNO
WOOD FINISH VERSION

ESSENZE DISPONIBILI (rovere venatura orizzontale)

AVAILABLE FINISHES
(oak with horizontal finish)

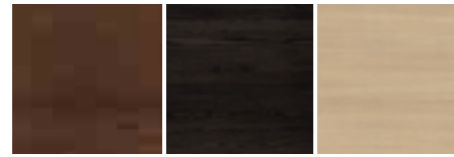

ROVERE TABACCO
TOBACCO OAK

ROVERE GRIGIO
GREY OAK

ROVERE SBIANCATO
BLEACHED OAK

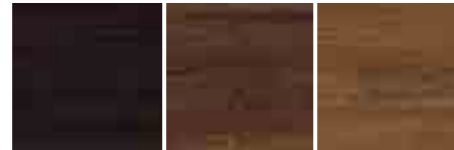

ROVERE WENGÈ
WENGÈ OAK

ROVERE CASTAGNO
CHESTNUT OAK

ROVERE TEAK
TEAK OAK

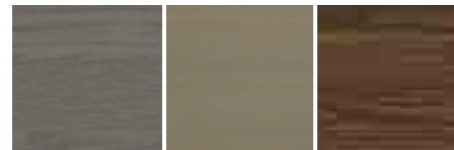

ROVERE PIETRA
STONE OAK

ROVERE GRIGIO CRETA
CLAY GREY OAK

ROVERE TERRA
EARTH OAK



ROVERE SETA
SILK OAK

ROVERE ICE
ICE OAK

COLORI DISPONIBILI (solo venatura orizzontale)

AVAILABLE FINISHES
(only for horizontal wood grain)



ROVERE LACCATO BIANCO
A PORO APERTO
WHITE
LACQUERED
OAK OPEN-PORE

ROVERE LACCATO RAL 9010
A PORO APERTO
OAK LACQUERED
RAL 9010 OPEN-
PORE

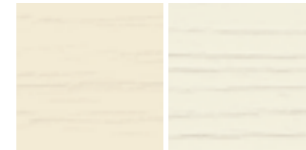

ROVERE LACCATO AVORIO
A PORO APERTO
IVORY
LACQUERED
OAK OPEN-PORE

ROVERE LACCATO RAL 9001
A PORO APERTO
OAK LACQUERED
RAL 9001 OPEN-
PORE

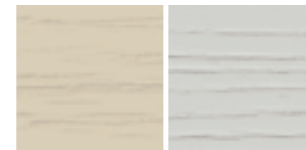

ROVERE LACCATO TORTORA
A PORO APERTO
DOVE GRAY
LACQUERED
OAK OPEN-
PORE

ROVERE LACCATO RAL 7035
A PORO APERTO
OAK LACQUERED
RAL 7035 OPEN-
PORE



MODELLI DISPONIBILI AVAILABLE MODELS

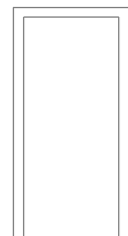

MOD. 1L

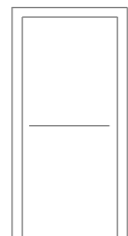

MOD. 1F

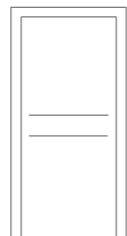

MOD. 2F

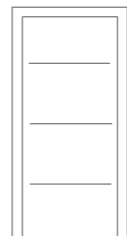

MOD. 3F



MOD. 5F

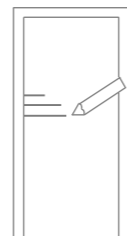

PANTOGRAFATURE
MODELLI:
MIRAWOOD
(SOLO SU ROVERE LACCATO
A PORO APERTO)

PANTOGRAPHED
MODELS AVAILABLE:
MIRAWOOD
(ONLY AVAILABLE FOR LACQUERED
OAK OPEN-PORE)

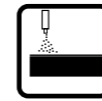

VERSIONE LACCATA.
LACQUERED VERSION.

COLORI DISPONIBILI COLOURS AVAILABLE

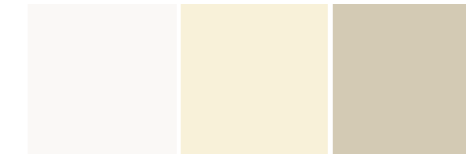

BIANCO
WHITE

AVORIO
IVORY

TORTORA
DOVE GREY

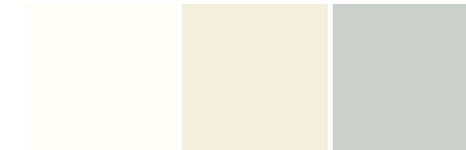

RAL 9010

RAL 9001

RAL 7035



COLORI RAL A RICHIESTA PER STILIA30. RAL COLOURS, UPON REQUEST.



MODELLI DISPONIBILI AVAILABLE MODELS



MOD. 1L

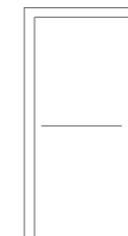

MOD. 1F

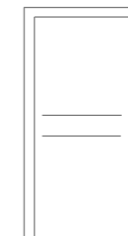

MOD. 2F

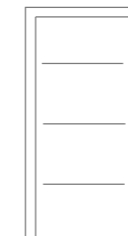

MOD. 3F



MOD. 5F

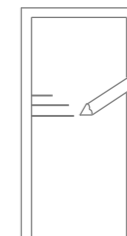

PANTOGRAFATURE
MODELLI:
MIRAQUADRA, MIRABILIA,
SUBLIMIA, PANGEA, DORE

PANTOGRAPHED
MODELS AVAILABLE:
MIRAQUADRA, MIRABILIA,
SUBLIMIA, PANGEA, DORE

Filomuro REI 60

VERSIONE GREZZA CON PRIMER
UNFINISH VERSION



GREZZA
CON FONDO
INTONACABILE
ENTRambi I LATI.
UNFINISHED
VERSION
PLASTERABLE
ON BOTH SIDES.

ELEMENTI DI SERIE PER MODELLO FILOMURO REI 60. STANDARD ELEMENTS FOR MODEL FILOMURO REI 60.

Serratura tipo yale SIC con cilindro chiave - chiave.
Cerniera a scomparsa. Chiudiporta a catena incassato a scomparsa.

Yale SIC lock with key-key cylinder. Concealed hinge.
Spring door closer.

Questa configurazione è di SERIE per la certificazione
UNI 1634-1, per le altre certificazioni potrebbe subire
cambiamenti.

This configuration is valid for the UNI 1634-1
certification, the standard configuration may vary.

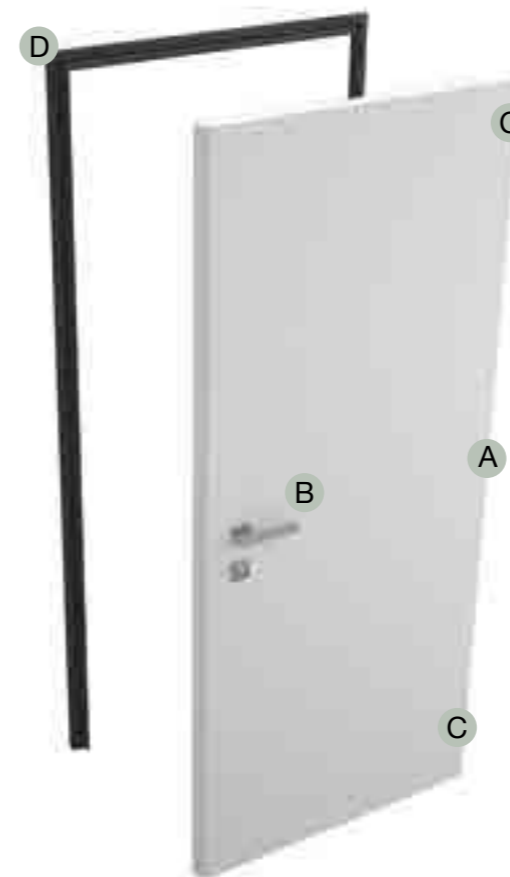

A Lato cerniere tipo a scomparsa.
Side hinges type a retractable.



B Serratura tipo yale SIC con cilindro chiave -
chiave.
Yale SIC lock with key-key cylinder.



Fornitura standard
3 chiavi
3 keys standard
providing

C Chiudiporta a catena incassato a scomparsa.
Spring door closer.



D Telaio in alluminio anodizzato spessore
FISSO 96 mm.
Frame in anodised aluminium with FIXED thi-
ckness of 96 mm.

Filomuro REI 60_

Sezione Filomuro REI 60_

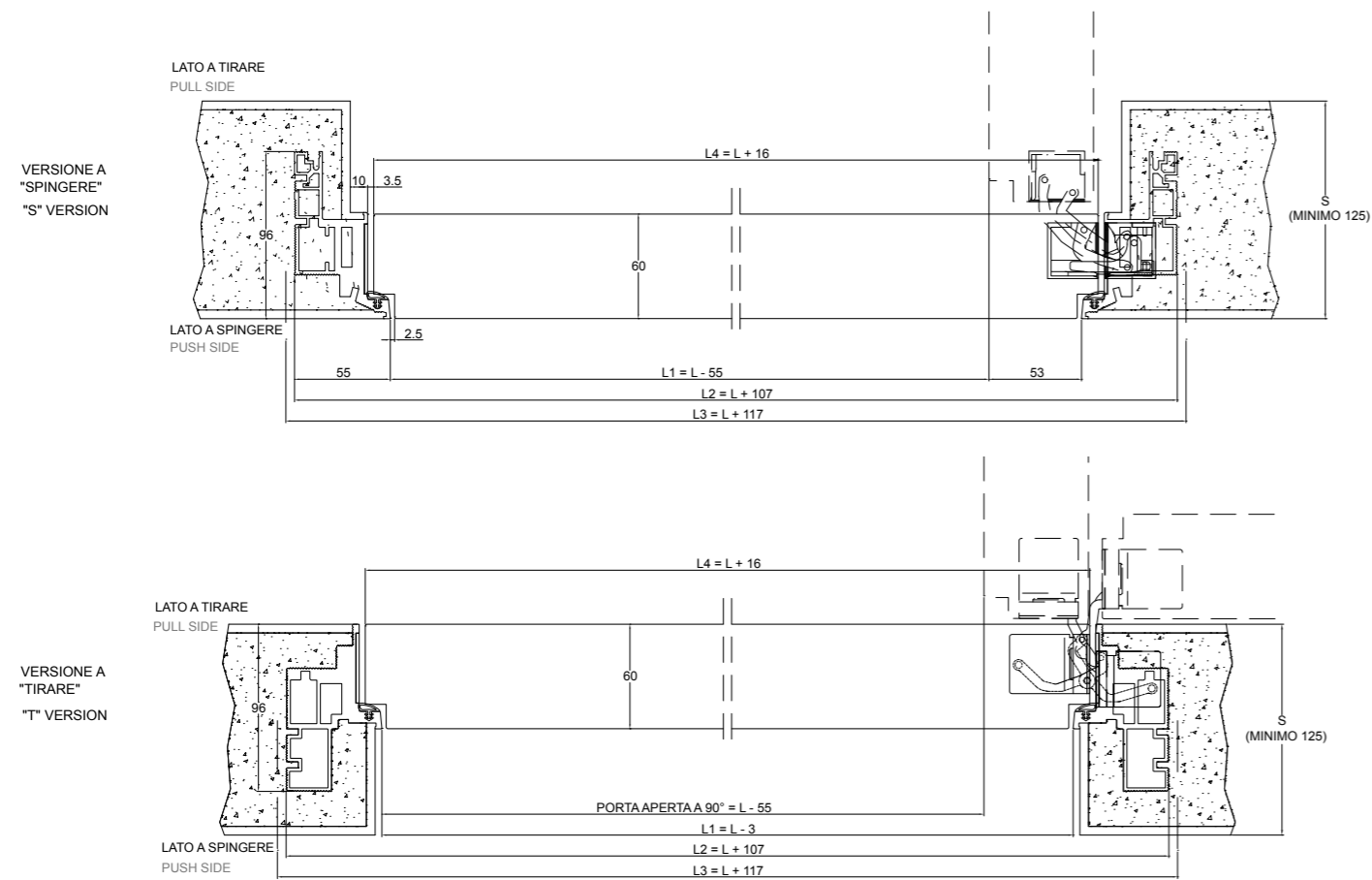

1_ANTA.DOOR.
2_TELAIO.FRAME.



Filomuro REI 60_

INFORMAZIONI TECNICHE TECHNICAL DATA

CARATTERISTICHE E PRESTAZIONI:

Certificata EI60 secondo UNI EN1634-1:2009. Prodotto omologato come da art.1 del D.M. 30/06/2004 dal Ministero dell'Interno con atto di omologazione AN170EI2060P008/ AN170EI1060P015.

CHARACTERISTICS AND PERFORMANCE:

EI60 certification in accordance with UNI EN1634-1:2009. Product type-approved in accordance with art.1 of M.D. of 30/06/2004 issued by the Ministry of the Interior with type approval act AN170EI2060P008/ AN170EI1060P015.

FONOSOLANZA

Nessun pacchetto acustico incluso di serie

SOUNDPROOFING

Sound insulation is not included as standard

Accessori

Accessories

FINITURE - SERVIZI OPTIONAL (a richiesta con supplemento)

FINISHES - OPTIONAL SERVICES (on request with surcharge)

OBLÒ A VETRO

GLASS PORTHOLE

C1 - FORMA RETTANGOLARE O QUADRATA (superficie max 0,25 mq) con vetro certificato EI 60 trasparente.

C1 - SQUARE OR RECTANGULAR SHAPE (max. surface area 0.25 m²) with transparent glass EI 60 certified.

C2 - FORMA RETTANGOLARE O QUADRATA (superficie max 0,25 mq) con vetro certificato EI 60 sabbiato.

C2 - Rectangular or square (surface max 0.25 m) with glass sandblasted EI 60 certified.

CONSEGNA TELAIO

FRAME DELIVERY

C3 - Gestione anticipata e separata per il solo Telaio.

C3 - Separate production and shipping of the frame.

C4 - Solo telaio 96mm.

C4 - Only 96mm frame.

C5 - Solo telaio in finitura laccato opaco tonalità bianco, avorio o tortora Garofoli RAL 7035 / RAL 9001 / RAL 9010.

C5 - Frame only with white, ivory or Garofoli light grey matt lacquer finish RAL 7035 / RAL 9001 / RAL 9010.

C6 - Solo telaio in finitura laccato opaco tonalità RAL.

C6 - Frame only with RAL matt lacquer finish.

C7 - Solo telaio in finitura laccato lucido tonalità bianco, avorio o tortora Garofoli.

C7 - Frame only with white, ivory or Garofoli light grey glossy lacquer finish.

C8 - Solo telaio in finitura laccato lucido tonalità RAL.

C8 - Frame only with RAL glossy lacquer finish.

C9 - Solo telaio in finitura anodizzato nero.

C9 - Frame only with black anodised finish.

KIT FONOSOLANZA

(abbattimento acustico) valido esclusivamente per porta in versione singola.

SOUND INSULATION KIT

(sound insulation) valid exclusively for single door.

E3 - Livello base 28db ottenuto con sola guarnizione saliscendi sotto porta.

D4 - 28db Base level achieved only with draught excluder.

E4 - Livello medio 38db ottenuto con guarnizione saliscendi sotto porta + materiale isolante interno "plus".

D5 - 38db mid level achieved with draught excluder + plus insulating material inside + sealing mastic.

E5 - Livello alto 42 ottenuto con guarnizione saliscendi sotto porta + materiale isolante interno "special".

D6 - 42 high level achieved with draught excluder + special insulating material inside.



CHIUDIPIORTA (abbinabili sia con cerniere a pomella, che a scomparsa)

DOOR CLOSER SYSTEMS (can be combined with both knob lock and hidden hinges)

D1 - Chiudiporta a scomparsa incassato (apertura max 120°)

D1 - Recessed concealed door closer (max opening 120°)



D2 - Chiudiporta aereo a braccio a "V" a cremagliera regolabile per forza e velocità apertura max 170°

D2 - Overhead "V" arm door closer and rack gear with adjustable force and speed, max opening 170°



D3 - Chiudiporta aereo a braccio e con slitta SLIM regolabile per forza e velocità apertura max 150°

D3 - Overhead door closer with arm and SLIM slide with adjustable force and speed, max opening 150°

D3A - Limitatore di apertura per chiudiporta aereo a braccio a slitta.

D3A - Opening limiter for overhead door closer with sliding arm.



CONTROPIASTRINO ELETTRICO MAGNETICO

MAGNETIC ELECTRIC STRIKE PLATE

I22 - posizionato sul montante telaio porta lato maniglia, predisposto per essere collegato ad un dispositivo elettronico per lo sblocco dello scrocco maniglia.

I22 - Positioned on the door frame upper on the handle side for connection to an electronic device for releasing the handle latch.

***Per serratura Yale SIC STD magnetica**

*For STD magnetic Yale SIC lock



I23 - posizionato sul montante telaio lato maniglia, predisposto per essere collegato ad un dispositivo elettronico per lo sblocco dello scrocco maniglia

I23 - Positioned on the door frame upper on the handle side for connection to an electronic device for releasing the handle latch

*** Per serratura antipanico OPERA XT o XT DQ**

* For XT or XT DQ OPERA hotel panic lock.



Gold REI 60_

1 |

VERSIONE
CON
FINITURA
LEGNO
WOOD
FINISH
VERSION

2 |

VERSIONE
IN
LAMINATO
LAMINATE
VERSION.

3 |

VERSIONE
LACCATA.
LACQUERED
VERSION.

4 |

RESISTENZA
AL FUOCO
60 MINUTI.
FIRE
RESISTANCE
60 MINUTES.

5 |

PORTA
SINGOLA.
SINGLE
DOOR.

6 |

PROVA FUMI.
SMOKE
TEST.

7 |

FONO
ISOLAMENTO
36 db
39 db
SOUND
INSULATION
36 db
39 db

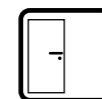

CARATTERISTICHE E PRESTAZIONI:

Porta resistente al fuoco in legno ad un'anta avente classificazione EI 60 - REI 60. Telaio sp. 40 mm. Mostre telescopiche del tipo ad incastro regolabili. Guarnizione acustica fumi freddi estrusa. Guarnizione intumescente autoadesiva. Montaggio consentito su pareti in muratura o cartongesso da sp. mm. 100 minimo con resistenza al fuoco EI 60 - REI 60. Anta sp. 60 mm, complanare lato a tirare al telaio e mostrine.

CHARACTERISTICS AND PERFORMANCE:

Wooden - single leaf fire resistant door with EI 60 performance. Main frame 40 mm thick. Adjustable telescopic trims. Extruded cold smoke seal. Intumescent autoadhesive seal. Installation allowed on gypsum board or masonry walls with minimum thickness of 100 mm and EI 60 fire resistance. Leaf thickness 60 mm, flush to frame and trims on pull side.





← elevator &
toilets
luggage room

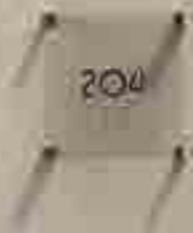

GOLD REI 60
ROVERE GRIGIO CRETA.
GOLD REI 60,
CLAY GREY OAK.

Gold REI 60_

GOLD REI 60 FINITURA MALTA
TECHNO MODELLO LISCIA 1L.

GOLD REI 60 MALTA TECHNO
FINISH 1L MODEL.



Gold REI 60



VERSIONE CON FINITURA LEGNO
WOOD FINISH VERSION

ESSENZE DISPONIBILI (rovere venatura orizzontale) AVAILABLE FINISHES (oak with horizontal finish)

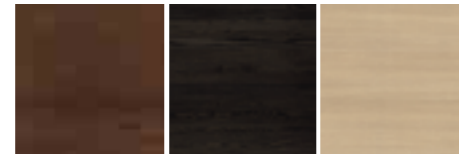

ROVERE TABACCO
TOBACCO OAK

ROVERE GRIGIO
GREY OAK

ROVERE SBIANCATO
BLEACHED OAK

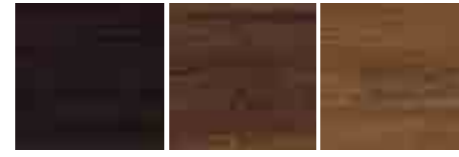

ROVERE WENGÈ
WENGÈ OAK

ROVERE CASTAGNO
CHESTNUT OAK

ROVERE TEAK
TEAK OAK

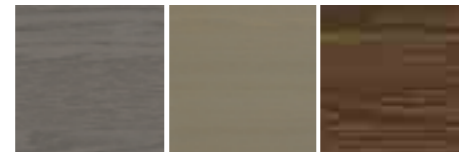

ROVERE PIETRA
STONE OAK

ROVERE GRIGIO CRETA
CLAY GREY OAK

ROVERE TERRA
EARTH OAK



ROVERE SETA
SILK OAK

ROVERE ICE
ICE OAK

COLORI DISPONIBILI (solo venatura orizzontale) AVAILABLE FINISHES (only for horizontal wood grain)



ROVERE LACCATO BIANCO
A PORO APERTO
WHITE LACQUERED
OAK OPEN-PORE

ROVERE LACCATO RAL 9010
A PORO APERTO
OAK LACQUERED
RAL 9010 OPEN-PORE

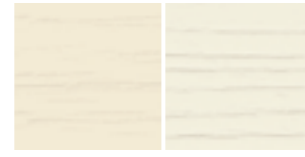

ROVERE LACCATO AVORIO
A PORO APERTO
IVORY LACQUERED
OAK OPEN-PORE

ROVERE LACCATO RAL 9001
A PORO APERTO
OAK LACQUERED
RAL 9001 OPEN-PORE



ROVERE LACCATO TORTORA
A PORO APERTO
DOVE GRAY LACQUERED
OAK OPEN-PORE

ROVERE LACCATO RAL 7035
A PORO APERTO
OAK LACQUERED
RAL 7035 OPEN-PORE

MODELLI DISPONIBILI AVAILABLE MODELS

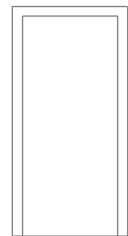

MOD. 1L

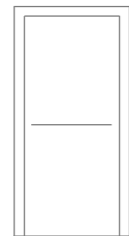

MOD. 1F

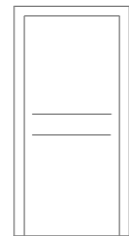

MOD. 2F

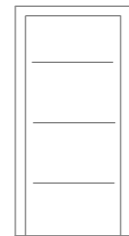

MOD. 3F

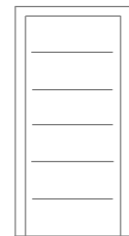

MOD. 5F



VERSIONE IN LAMINATO
LAMINATE VERSION.



ESSENZE DISPONIBILI AVAILABLE FINISHES

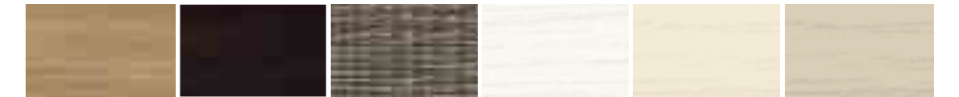

ROVERE SBIANCATO
BLEACHED OAK

ROVERE WENGÈ
WENGÈ OAK

ROVERE INTARSIO
INLAID OAK

FRASSINO BIANCO
WHITE ASH

FRASSINO AVORIO
IVORY ASH

FRASSINO TORTORA
DOVE GREY ASH



QUERCIA BIANCO
QUERCIA WHITE

QUERCIA GESSO
QUERCIA OFF-WHITE

QUERCIA SBIANCATO
QUERCIA BLEACHED

QUERCIA BIONDO
QUERCIA BLONDE

QUERCIA GRIGIO
QUERCIA GREY

QUERCIA DECAPÈ
QUERCIA PICKLED



QUERCIA SCURO
QUERCIA DARK

OLMO GHIACCIO
ICE ELM

OLMO SABBIA
SAND ELM

OLMO GRIGIO
GREY ELM

BIANCO VENATO
GRAINED WHITE

NOCE CANALETTO
CANALETTO WALNUT



MALTA BIANCO
WHITE CEMENT

MALTA NUVOLA
CLOUD CEMENT

MALTA CEMENTO
PURE CEMENT

MALTA TECHNO
TECHNO CEMENT

MALTA GRIGIO
GREY CEMENT

MALTA CORTEN
WHITE CORTEN



BIANCO TRAMA
WHITE WEAVE

BIANCO ARTE
ART WHITE

BIANCO CORTECCIA
WHITE BARK

BIANCO LASER
LASER WHITE

BIANCO ONDA
WAVE WHITE

BIANCO QUADRO
QUADRO WHITE



MALTA ORO GRIGIO
GREY GOLD CEMENT

MALTA ORO NERO
BLACK GOLD CEMENT

MALTA SABBIA
WHITE SAND

BIANCO
WHITE

AVORIO
IVORY

MODELLI DISPONIBILI AVAILABLE MODELS



MOD. 1L



MOD. 1F

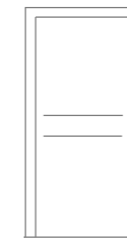

MOD. 2F

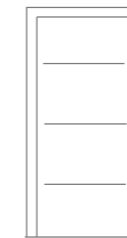

MOD. 3F



MOD. 5F

1. TELAIO E MOSTRINE LISCE
NON TEXTURIZZATI
NON-TEXTURED, SMOOTH
FRAME AND JAMBS

2. TELAIO E MOSTRINE
BIANCO LISCIO
WHITE SMOOTH FRAME
AND JAMBS

Gold REI 60



VERSIONE LACCATA.
LACQUERED VERSION.

COLORI DISPONIBILI COLOURS AVAILABLE

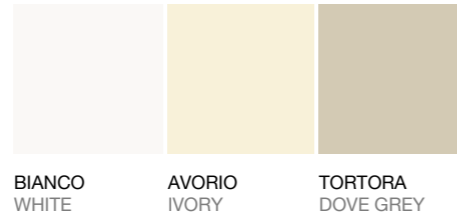

BIANCO
WHITE

AVORIO
IVORY

TORTORA
DOVE GREY

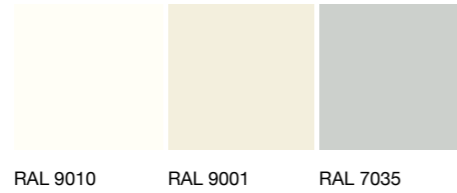

RAL 9010

RAL 9001

RAL 7035

COLORI RAL A RICHIESTA PER STILIA30. RAL COLOURS, UPON REQUEST.



MODELLI DISPONIBILI AVAILABLE MODELS

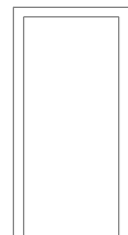

MOD. 1L

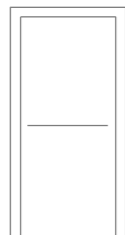

MOD. 1F

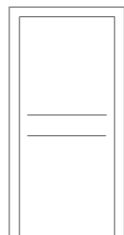

MOD. 2F

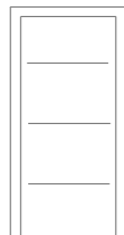

MOD. 3F



MOD. 5F

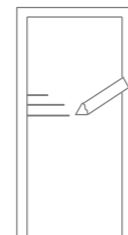

PANTOGRAFATURE
MOD. MIRAQUADRA,
MIRABILIA, SUBLIMIA,
PANGEA, DORE.

PANTOGRAPHED
MODELS AVAILABLE:
MOD. MIRAQUADRA,
MIRABILIA, SUBLIMIA,
PANGEA, DORE.

ELEMENTI DI SERIE PER MODELLO GOLD REI 60. STANDARD ELEMENTS FOR MODEL GOLD REI 60.

Serratura tipo yale sic con cilindro chiave-chiave. Cerniere tipo pomella. Chiudiporta integrato pomella auto - chiudente. Elementi: rostri metallici di tenuta e guarnizioni intumescenti.

Yale sic lock with key-key cylinder. Knob lock hinge 2+1. Built-in door closure device self-closing knob lock. Elements: metal nib sealing elements and intumescent seals.

Questa configurazione è di SERIE per la certificazione UNI 1634-1, per le altre certificazioni potrebbe subire cambiamenti.

This configuration is valid for the UNI 1634-1 certification. the standard configuration may vary.



A Lato con cerniera a scomparsa F.
F Concealed hinges.



B Serratura yale sic con cilindro chiave-chiave.
Yale sic lock with key-key cylinder.



Fornitura standard
3 chiavi
3 keys standard
providing

C Chiudiporta aereo a braccio e con slitta.
Overhead door closing arm with slide.



D Mostrine lisce piatte da 88 mm sia sul lato esterno (spingere porta) sia sul lato interno (tirare porta)
Smooth flat trims size 88 mm on both sides of the door

E Telaio. Frame.

Le porte REI 30 certificate sono realizzabili esclusivamente nella versione a battente, senza sopra luce.
REI 30 certified doors are only available in the single hinged version, without transom light.

Gold REI 60_

INFORMAZIONI TECNICHE TECHNICAL DATA

CARATTERISTICHE E PRESTAZIONI:

Certificata EI60 secondo UNI EN1634-1:2009. Prodotto omologato come da art.1 del D.M. 30/06/2004 dal Ministero dell'Interno con atto di omologazione AN170EI2060P008/ AN170EI1060P015.

CHARACTERISTICS AND PERFORMANCE:

EI60 certification in accordance with UNI EN1634-1:2009. Product type-approved in accordance with art.1 of M.D. of 30/06/2004 issued by the Ministry of the Interior with type approval act AN170EI2060P008/ AN170EI1060P015.

FONOSOLANZA

Nessun pacchetto acustico incluso di serie

SOUND INSULATION

Sound insulation is not included as standard

Sezione Gold REI 60_

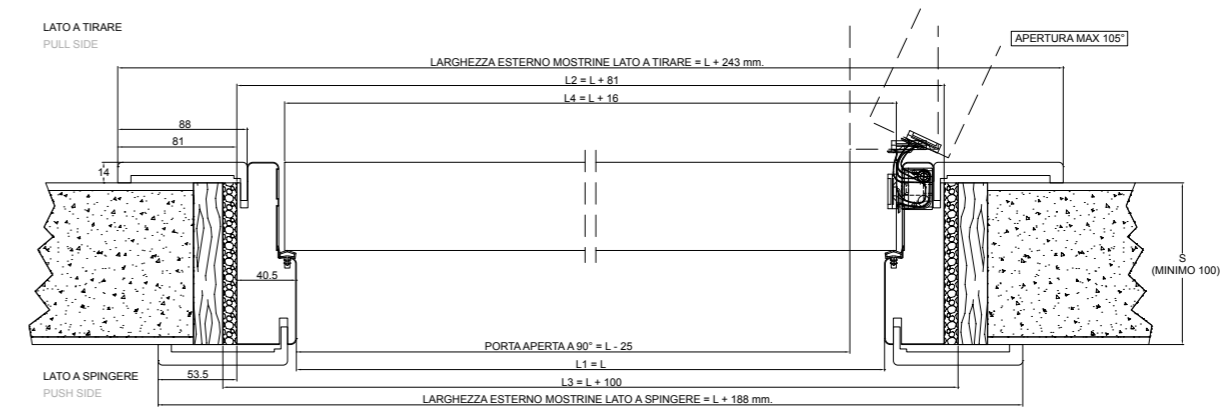

- 1_ANTA.DOOR.
- 2_MOSTRINE.TRIMS.
- 3_TELAIO.FRAME.

Accessori

Accessories

SISTEMI DI CHIUSURA OPTIONAL (a richiesta con supplemento)

OPTIONAL CLOSER SYSTEMS (on request with surcharge)

C1 - Lato cerniera tipo pomella.

C1 - Knob lock hinges.

C2 - Cerniere tipo a scomparsa regolabile.

C2 - Adjustable hidden hinges.



CHIUDIPORTA (abbinabili sia con cerniere a pomella, che a scomparsa)

DOOR CLOSER SYSTEMS (can be combined with both knob lock and hidden hinges)

C3 - Chiudiporta a scomparsa ad incassato lato superiore anta e telaio.

C3 - Recessed hidden door closer system on top of door and frame.



C4 - Chiudiporta aereo a braccio a "V" a cremagliera.

C4 - "V"-shaped overhead door closing arm with rack.



KIT FONOSOLANZA

(abbattimento acustico) valido esclusivamente per porta in versione singola.

SOUND INSULATION KIT

(sound insulation) valid exclusively for single version door.

D2 - Livello medio 36dB ottenuto con guarnizione saliscendi sotto porta + materiale isolante interno plus + mastice sigillante.

D2 - 31dB Mid level achieved with draught excluder + insulating material inside plus + sealing mastic.



D3 - Livello alto 39dB ottenuto con guarnizione saliscendi sotto porta + materiale isolante interno special + mastice sigillante.

D3 - 34dB High level achieved with draught excluder + insulating material inside special + sealing mastic.



CONTROPIASTRINI ELETTRICO MAGNETICO

MAGNETIC ELECTRIC STRIKE PLATE

I20 - Posizionato sul montante telaio della porta dal lato maniglia. Accessorio predisposto per essere collegato ad un dispositivo elettronico per lo sblocco dello scrocco maniglia.

H20 - Positioned on the door frame upright on the handle side. Accessory designed to be connected to an electronic device for unlocking the handle latch.



Per serrature optional, supplementi per mostrine di larghezza maggiorata, maggiorazioni per misure non standard consultare il listino prezzi.

For optional locks, surcharges for oversized width trims, surcharges for non-standard sizes, consult the price list.

REI 120_

1 |

VERSIONE
CON
FINITURA
LEGNO
WOOD
FINISH
VERSION.



2 |

VERSIONE
LACCATA.
LACQUERED
VERSION.



3 |

RESISTENZA
AL FUOCO
120 MINUTI.
FIRE
RESISTANCE
120 MINUTES.



4 |

PORTA
SINGOLA.
SINGLE
DOOR.

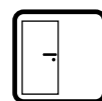

5 |

PORTA
DOPPIA.
DOUBLE-
DOOR.



CARATTERISTICHE E PRESTAZIONI:

Porta resistente al fuoco in legno ad un'anta avente classificazione EI 120 - REI 120. Telaio sp. 85 mm. Mostre telescopiche regolabili. Guarnizione acustica fumi freddi estrusa. Guarnizione intumescente autoadesiva. Montaggio consentito su pareti in muratura o cartongesso da sp. mm. 110 minimo con resistenza al fuoco EI 120 - REI 120. Anta sp. 90 mm. Guarnizioni intumescenti sui bordi dell'anta e del telaio.

CHARACTERISTICS AND PERFORMANCE:

Wooden - single leaf fire resistant door with EI120 performance. Main frame 85 mm thick. Adjustable telescopic covering profiles. Extruded cold smoke seal. Intumescent autoadhesive seal. Installation allowed on gypsum board or masonry walls with minimum thickness of 110 mm and EI 120 fire resistance. Leaf 90 mm thick. Intumescent gasket on the frame and on the leaf edges.



REI 120

REI 120, FINITURA
ROVERE TABACCO.

REI 120, TOBACCO
OAK FINISH.



REI 120_

REI 120 VERSIONE LACCATO
OPACO COLORE RAL.

REI 120 VERSION MATT LAC-
QUERED COLOUR RAL.

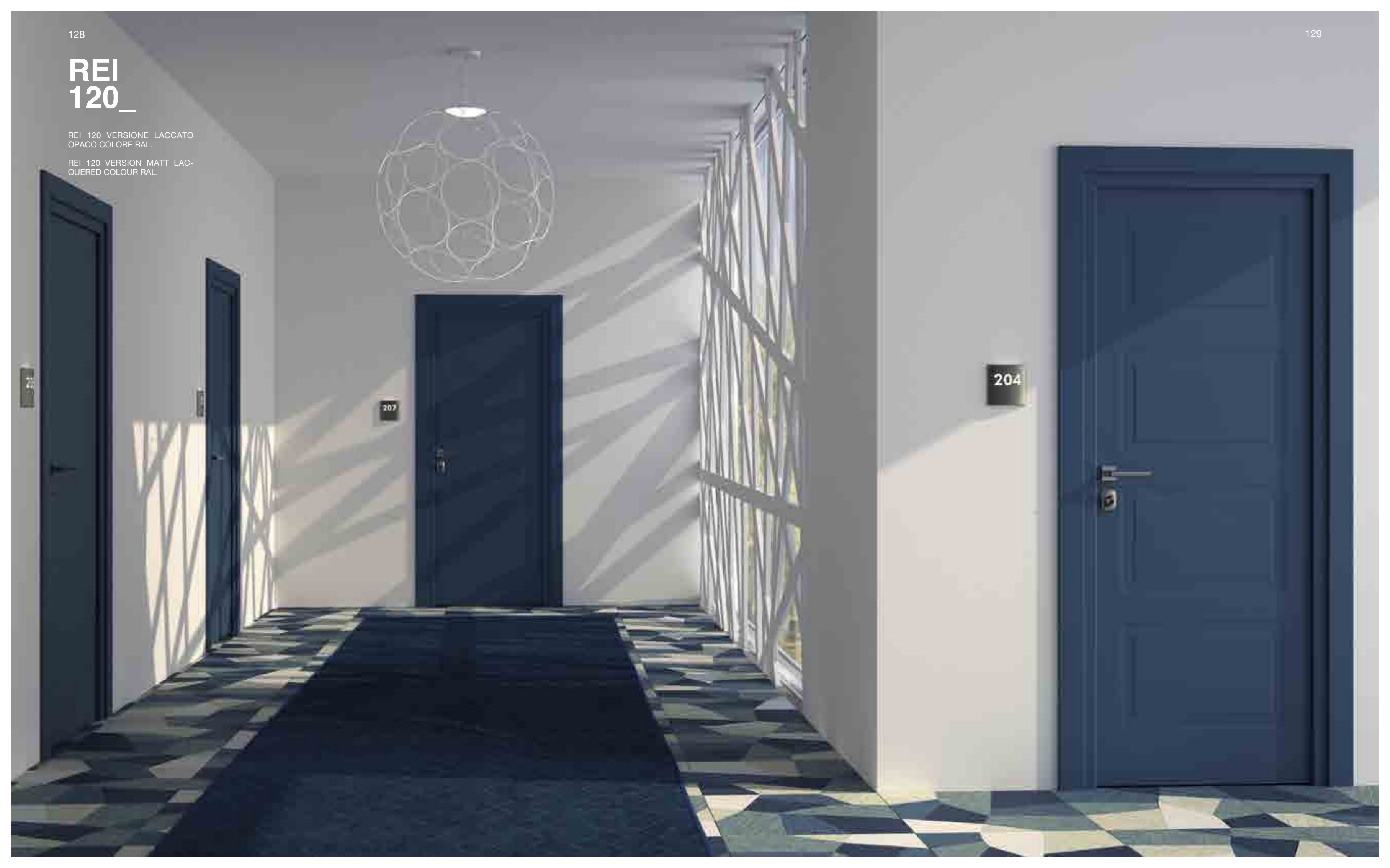



SULLA DESTRA: PORTA REI 120, VERSIONE DOPPIA, ANTE APERTE. FINITURA LACCATO BIANCO. SULLA SINISTRA: PORTA REI 120, FINITURA ROVERE ICE. BOISERIE ROVERE ICE.

ON THE RIGHT: REI 120 DOOR, DOUBLE VERSION, OPEN DOORS. WHITE LACQUERED FINISH. ON THE LEFT: REI 120 DOOR, ICE OAK FINISH. WOODEN PANELING IN ICE OAK FINISH.

SULLA DESTRA: PORTA REI 120, VERSIONE DOPPIA, ANTE CHIUSE. FINITURA LACCATO BIANCO. SULLA SINISTRA: PORTA REI 120, FINITURA ROVERE ICE. BOISERIE ROVERE ICE.

ON THE RIGHT: REI 120 DOOR, DOUBLE VERSION, CLOSED DOORS. WHITE LACQUERED FINISH. ON THE LEFT: REI 120 DOOR, ICE OAK FINISH. WOODEN PANELING IN ICE OAK FINISH.

REI 120_



VERSIONE CON FINITURA LEGNO
WOOD FINISH VERSION

ESSENZE DISPONIBILI
(rovere venatura orizzontale)
AVAILABLE FINISHES
(oak with horizontal finish)

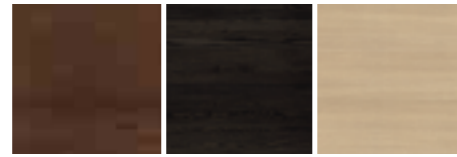

ROVERE
TABACCO
TOBACCO OAK

ROVERE
GRIGIO
GREY OAK

ROVERE
SBIANCATO
BLEACHED OAK

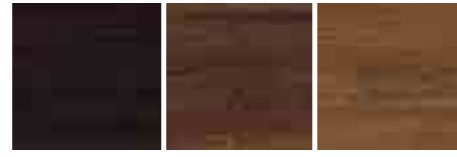

ROVERE
WENGÈ
WENGÈ OAK

ROVERE
CASTAGNO
CHESTNUT OAK

ROVERE
TEAK
TEAK OAK

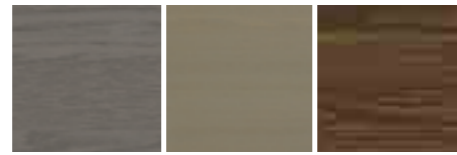

ROVERE
PIETRA
STONE OAK

ROVERE
GRIGIO CRETA
CLAY GREY OAK

ROVERE
TERRA
EARTH OAK



ROVERE
SETA
SILK OAK

ROVERE
ICE
ICE OAK

COLORI DISPONIBILI
(solo venatura orizzontale)
AVAILABLE FINISHES
(only for horizontal wood grain)



ROVERE
LACCATO
BIANCO
A PORO APERTO
WHITE
LACQUERED
OAK OPEN-PORE

ROVERE
LACCATO RAL
9010
A PORO APERTO
OAK LACQUERED
RAL 9010 OPEN-
PORE



ROVERE
LACCATO
AVORIO
A PORO APERTO
IVORY
LACQUERED
OAK OPEN-PORE

ROVERE
LACCATO RAL
9001
A PORO APERTO
OAK LACQUERED
RAL 9001 OPEN-
PORE



ROVERE
LACCATO
TORTORA
A PORO
APERTO
DOVE GRAY
LACQUERED
OAK OPEN-
PORE

ROVERE
LACCATO RAL
7035
A PORO APERTO
OAK LACQUERED
RAL 7035 OPEN-
PORE



MODELLI DISPONIBILI
AVAILABLE MODELS

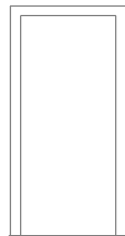

MOD. 1L

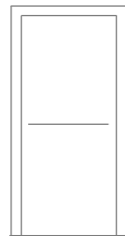

MOD. 1F

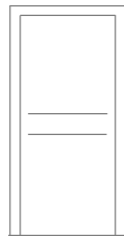

MOD. 2F

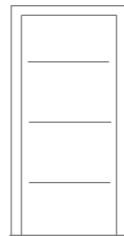

MOD. 3F



MOD. 5F

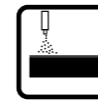

VERSIONE LACCATA.
LACQUERED VERSION.

COLORI DISPONIBILI
COLOURS AVAILABLE



BIANCO
WHITE

AVORIO
IVORY

TORTORA
DOVE GREY



RAL 9010

RAL 9001

RAL 7035



COLORI RAL A RICHIESTA PER STILIA30. RAL COLOURS, UPON REQUEST.



MODELLI DISPONIBILI
AVAILABLE MODELS

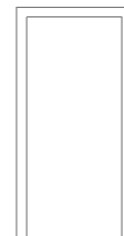

MOD. 1L

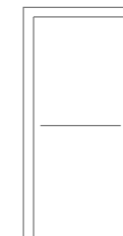

MOD. 1F

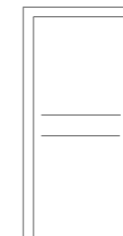

MOD. 2F



MOD. 3F



MOD. 5F

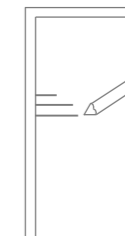

PANTOGRAFATURE
MOD. MIRAQUADRA
MIRABILA, SUBLIMIA,
PANGEA, DORÉ.

PANTOGRAPHED
MODELS AVAILABLE:
MOD. MIRAQUADRA
MIRABILA, SUBLIMIA,
PANGEA, DORÉ.

REI 120_

ELEMENTI DI SERIE PER MODELLO REI 120 A BATTENTE SINGOLA STANDARD ELEMENTS FOR MODEL REI 120 SINGLE HINGED DOOR

Serratura Tipo yale SIC con cilindro chiave-chiave. Cerniere tipo pomella 3D. Chiudiporta braccio a "V". Lama tagliafreddo sali/scendi sotto anta.

Yale SIC lock with key-key cylinder. 3D, knob lock hinges. "V"-shaped overhead door closing arm. Draught excluder under door.

Questa configurazione è di SERIE per la certificazione UNI 1634-1, per le altre certificazioni potrebbe subire cambiamenti.

This configuration is valid for the "UNI 1634-1" certification. For other certifications, the standard configuration may vary.



- A** Cerniere pomella 3D.
3D Knoblock hinges.



- B** Serratura tipo Yale SIC con cilindro chiave-chiave.
Yale SIC lock with key-key cylinder.



Fornitura standard
3 chiavi
3 keys standard
providing

- C** Chiudiporta aereo Braccio a "V".
"V"-shaped overhead door closing arm.



- D** Lama tagliafreddo sali/scendi sotto anta.
Draught excluder under door.



- E** Mostrine lisce piatte da 88 mm. sia sul lato esterno (spingere porta) sia sul lato interno (tirare porta).
Smooth flat trims size 88 mm on both sides of the door.

- F** Telaio. Frame.

REI 120_

ELEMENTI DI SERIE PER MODELLO REI 120 A BATTENTE DOPPIA STANDARD ELEMENTS FOR MODEL REI 120 DOUBLE HINGED DOOR

Serratura tipo yale SIC con cilindro chiave-chiave. Contro-serratura + ferramenta per anta secondaria. Cerniere a pomella 3d. Chiudiporta braccio a "V" a cremagliera. Sequenziatore chiusura ante. Lama tagliafreddo sali/scendi sotto anta.

Yale SIC lock with key-key cylinder. Lock striker + hardware for second door. 3D knob lock hinges. "V"-shaped overhead door closing arm with rack. Door closure sequencer. Sliding draught excluder under door.

Questa configurazione è di SERIE per la certificazione UNI 1634-1, per le altre certificazioni potrebbe subire cambiamenti.

This configuration is valid for the "UNI 1634-1" certification. For other certifications, the standard configuration may vary.



- A** Cerniera tipo pomella 3D
3D knob lock hinges.



- B** Serratura Tipo yale SIC con cilindro chiave-chiave. Contro-serratura + ferramenta per anta secondaria.

Yale SIC lock with key-key cylinder. Lock striker + hardware for second door.



Fornitura standard
3 chiavi
3 keys standard
providing

- C** Chiudiporta aereo Braccio a "V".
"V"-shaped overhead door closing arm.



- D** Lama tagliafreddo sali/scendi sotto anta.
Draught excluder under door.



- E** Sequenziatore chiusura ante.
Door closer sequencer.



- F** Mostrine lisce piatte da 88 mm. sia sul lato esterno (spingere porta) sia sul lato interno (tirare porta).
Smooth flat trims size 88 mm on both sides of the door.

- G** Telaio. Frame.

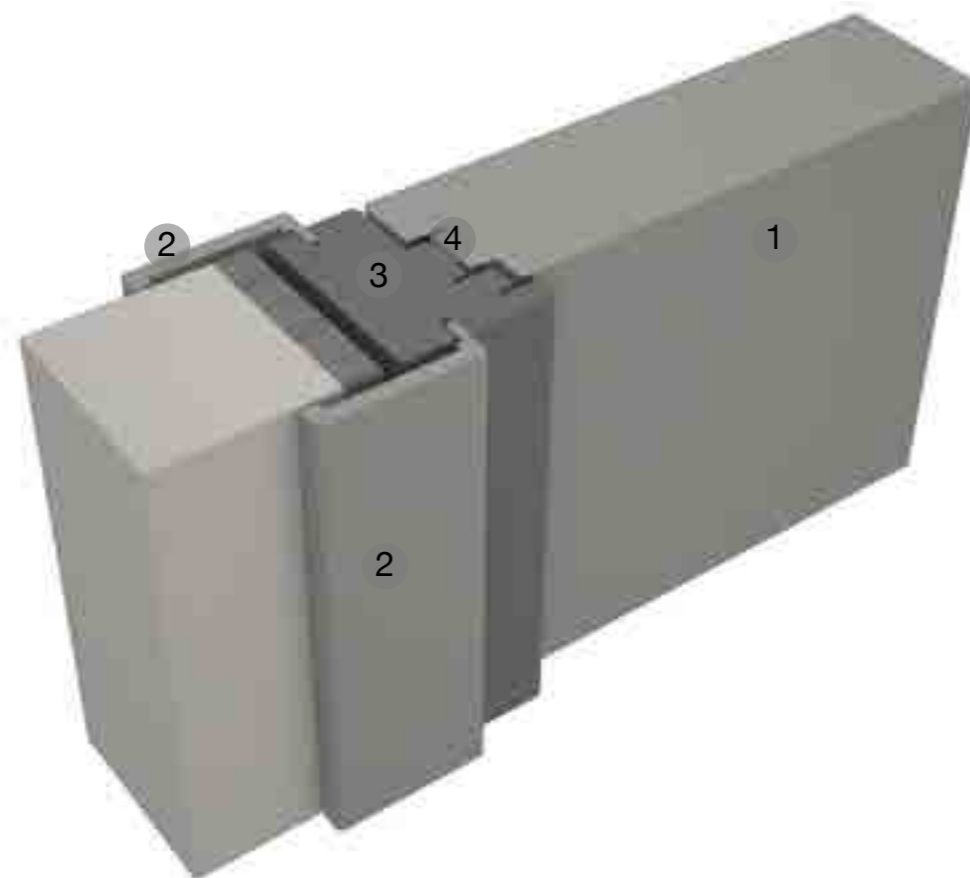
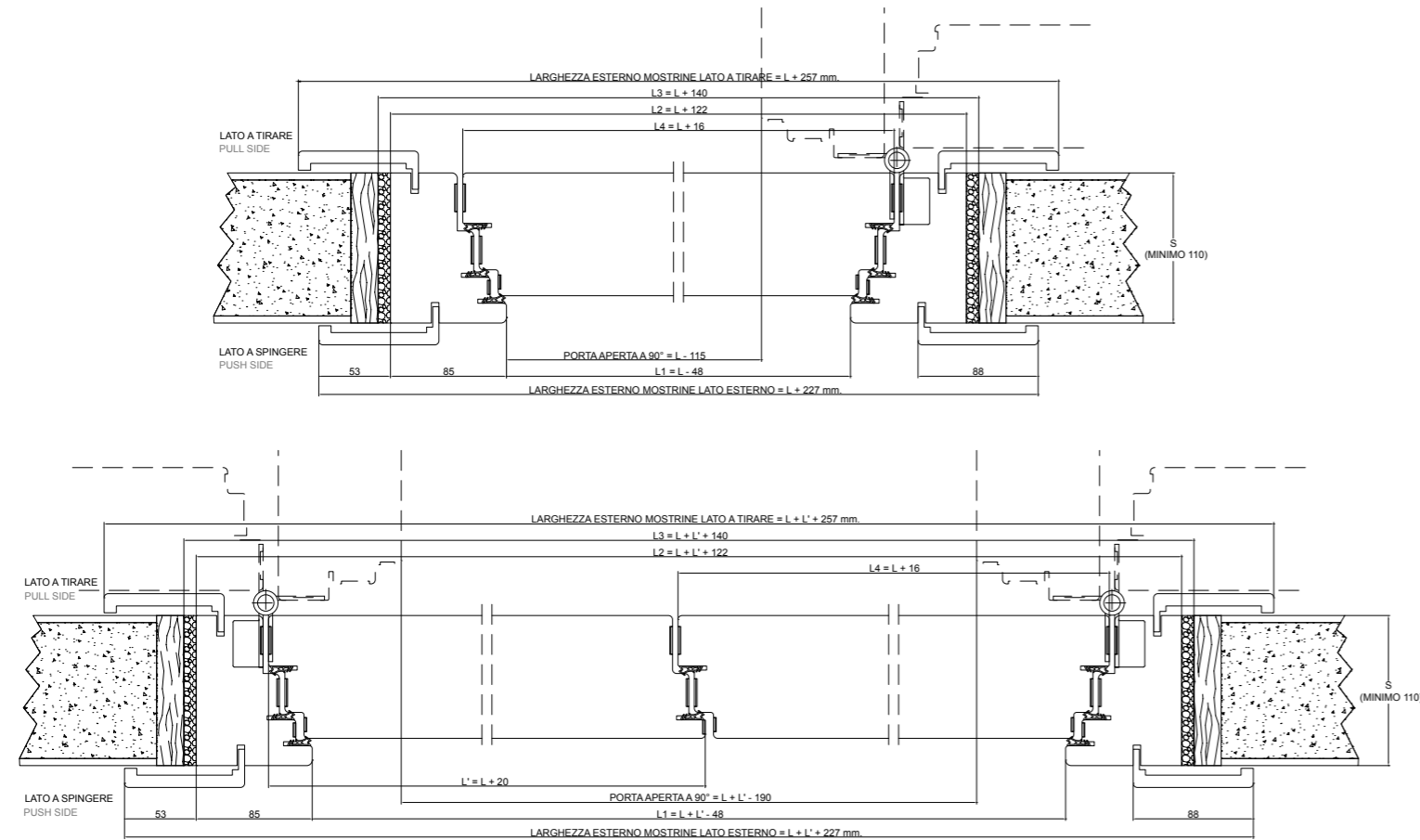
Sezione **REI 120_**

- 1_ANTA.DOOR.
- 2_MOSTRINE.TRIMS.
- 3_TELAIO.FRAME.
- 4_GUARNIZIONI.SEALS.

**REI
120_****INFORMAZIONI TECNICHE**
TECHNICAL DATA**CARATTERISTICHE E PRESTAZIONI:**

Certificata EI120 secondo UNI EN1634-1:2009. Prodotto omologato come da art.1 del D.M. 30/06/2004 dal Ministero dell'Interno con atto di omologazione AN170EI1120P013.

CHARACTERISTICS AND PERFORMANCE:

EI120 certification in accordance with UNI EN1634-1:2009. Product type-approved in accordance with art.1 of M.D. of 30/06/2004 issued by the Ministry of the Interior with type approval act AN170EI1120P013.

FONOSOLANZA

Nessun pacchetto acustico incluso di serie

SOUNDPROOFING

Sound insulation is not included as standard

Accessori Accessories

CHIUDIORTA (sistemi di chiusura optional a richiesta con supplemento)
DOOR CLOSER SYSTEMS (optional closer systems on request with surcharge)

C1 - Chiudiporta a scomparsa incassato (apertura max 120°)
C1 - Recessed concealed door closer (max opening 120°)

C2 - Chiudiporta aereo a braccio e con slitta regolabile per forza e velocità apertura max 150°
C2 - Overhead door closer with arm and slide with adjustable force and speed, max opening 150°

C2A - Limitatore di apertura per chiudiporta aereo a braccio a slitta
C2A - Opening limiter for overhead door closer with sliding arm.

C3 - Chiudiporta aereo a braccio e con slitta con sequenziatore di chiusura incorporato.
Apertura max 150°.
C3 - Overhead door closer with arm and slide with built-in closing sequencer. Max opening 150°.

C3A - Chiudiporta aereo a braccio e con slitta con sequenziatore di chiusura incorporato e fermaporta elettromeccanico. Apertura max 150°.
C3A - Overhead door closer with arm and slide with built-in closing sequencer and electromechanical door stop. Max opening 150°.

C4 - Chiudiporta a scomparsa ad incassato lato superiore anta e telaio (per porta doppia).
C4 - Recessed concealed door closure system on top of door and frame (for double doors).

C5 - Chiudiporta a scomparsa ad incassato lato superiore anta e telaio e sequenziatore incorporato con fermaporta elettromeccanico (per porta doppia).
C5 - Concealed door closure recessed above the door and frame and built-in sequencer with electromechanical door stop (for double door).

Nota: inserendo questo sistema, la larghezza minima realizzabile delle ante diventa: 550 mm.
Note: when using this system, the minimum possible door width becomes: 550 mm.

SERVIZI OPTIONAL (a richiesta con supplemento)
OPTIONAL SERVICES (on request with surcharge)

OBLÒ A VETRO
GLASS PORTHOLE

C1 - FORMA ROTONDA (superficie max 0,25 mq) con vetro certificato EI 120 trasparente.
C1 - ROUND SHAPE (max. surface area 0.25 m²) with transparent glass EI 120 certified.

C2 - FORMA ROTONDA (superficie max 0,25 mq) con vetro certificato EI 120 sabbato.
C2 - ROUND SHAPE (max. surface area 0.25 m²) with glass sandblasted EI 120 certified.

C3 - FORMA RETTANGOLARE O QUADRATA (superficie max 0,25 mq) con vetro certificato EI 120 trasparente.
C3 - SQUARE OR RECTANGULAR SHAPE (max. surface area 0.25 m²) with transparent glass EI 120 certified.

C4 - FORMA RETTANGOLARE O QUADRATA (superficie max 0,25 mq) con vetro certificato EI 120 sabbato.
C4 - Rectangular or square (surface max 0.25 m²) with glass sandblasted EI 120 certified.



CONTROPIASTRINI ELETTRICO MAGNETICO
MAGNETIC ELECTRIC STRIKE PLATE

I20 - Posizionato sul montante telaio della porta dal lato maniglia. Accessorio predisposto per essere collegato ad un dispositivo elettronico per lo sblocco dello scrocco maniglia.

I20 - Positioned on the door frame upright on the handle side. Accessory designed to be connected to an electronic device for unlocking the handle latch.

Per serrature optional, supplementi per mostrine di larghezza maggiorata, maggiorazioni per misure non standard consultare il listino prezzi.

For optional locks, surcharges for oversized width trims, surcharges for non-standard sizes, consult the price list.



Filomuro REI 120_

1 |

VERSIONE
LACCATA.
LACQUERED
VERSION.

2 |

PORTA
SINGOLA.
SINGLE
DOOR.

3 |

FONO
ISOLAMENTO
47 db
SOUND
INSULATION
47 db

4 |

RESISTENZA
AL FUOCO
120 MINUTI.
FIRE
RESISTANCE
120 MINUTES.

5 |

OBLÒ
RETTANGO-
LARE MAX 0,25
MQ.
RECTANGULAR
PORTHOLE
MAX. 0.25 M2.

6 |

UTILIZZABILE COME
USCITA DI EMERGENZA
CON PASSAGGIO UTILE DI
1200 MM.
CAN BE USED AS AN
EMERGENCY EXIT WITH
OPENING OF 1,200 MM.

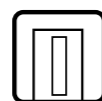
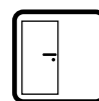
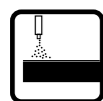

CARATTERISTICHE E PRESTAZIONI:

Porta resistente al fuoco in legno ad un'anta avente classificazione EI 120 - REI 120. Telaio sp. 85 mm. Mostre telescopiche regolabili. Guarnizione acustica fumi freddi estrusa. Guarnizione intumescente autoadesiva. Montaggio consentito su pareti in muratura o cartongesso da sp. mm. 110 minimo con resistenza al fuoco EI 120 - REI 120. Anta sp. 90 mm. Guarnizioni intumescenti sui bordi dell'anta e del telaio.

CHARACTERISTICS AND PERFORMANCE:

Wooden - single leaf fire resistant door with EI120 performance. Main frame 85 mm thick. Adjustable telescopic covering profiles. Extruded cold smoke seal. Intumescent autoadhesive seal. Installation allowed on gypsum board or masonry walls with minimum thickness of 110 mm and EI 120 fire resistance. Leaf 90 mm thick. Intumescent gasket on the frame and on the leaf edges.



Filomuro REI 120_

REI 120 VERSIONE GREZZA
CON FONDO INTONACABILE.

REI 120 RAW VERSION WITH
PLASTER-READY BOTTOM.

005



Filomuro REI 120_

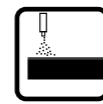

VERSIONE LACCATA.
LACQUERED VERSION.

COLORI DISPONIBILI
COLOURS AVAILABLE

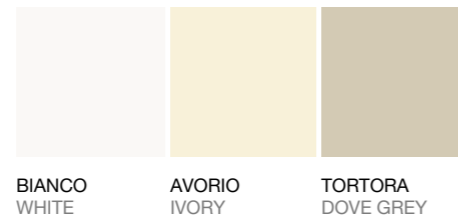

BIANCO
WHITE

AVORIO
IVORY

TORTORA
DOVE GREY

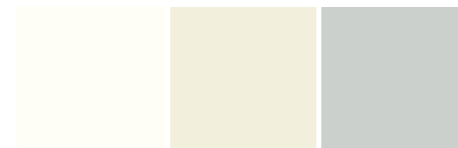

RAL 9010

RAL 9001

RAL 7035

COLORI RAL A RICHIESTA PER STILIA30. RAL COLOURS, UPON REQUEST.



MODELLI DISPONIBILI
AVAILABLE MODELS

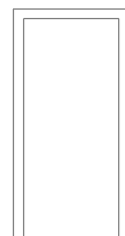

MOD. 1L

VERSIONE GREZZA CON PRIMER
UNFINISH VERSION

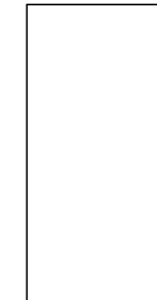

GREZZA
CON FONDO
INTONACABILE
ENTRABI LATI.
UNFINISHED
VERSION
PLASTERABLE
ON BOTH SIDES.

MODELLI DISPONIBILI
AVAILABLE MODELS



MOD. 1L

Filomuro REI 120_

ELEMENTI DI SERIE PER MODELLO REI 120 A BATTENTE SINGOLA STANDARD ELEMENTS FOR MODEL REI 120 SINGLE HINGED DOOR

Serratura Tipo yale SIC con cilindro chiave-chiave. Cerniere tipo pomella 3D. Chiudiporta braccio a "V". Lama tagliafreddo sali/scendi sotto anta.

Yale SIC lock with key-key cylinder. 3D, knob lock hinges. "V"-shaped overhead door closing arm. Draught excluder under door.

Questa configurazione è di SERIE per la certificazione UNI 1634-1, per le altre certificazioni potrebbe subire cambiamenti.

This configuration is valid for the "UNI 1634-1" certification. For other certifications, the standard configuration may vary.

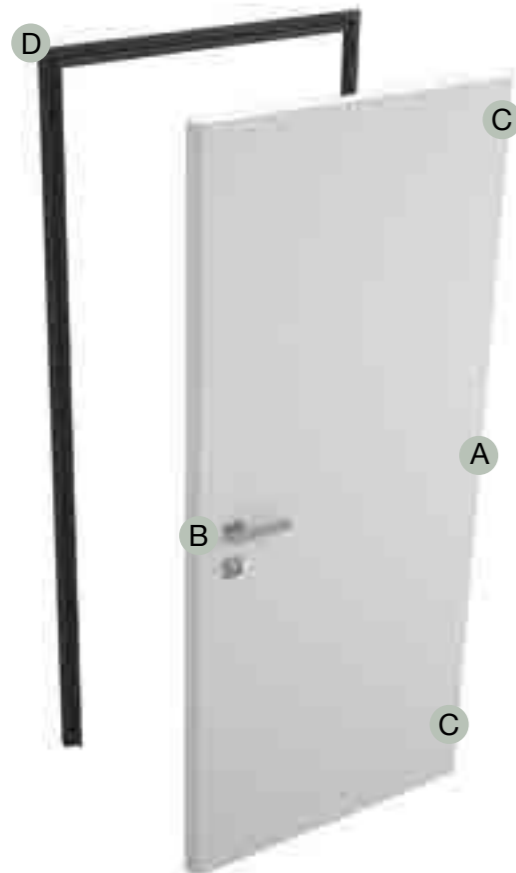

- A** Lato cerniere tipo a scomparsa.
Side hinges type a retractable.



- B** Serratura tipo yale SIC con cilindro chiave-chiave.
Yale SIC lock with key-key cylinder.



Fornitura standard
3 chiavi
3 keys standard
providing

- C** Chiudiporta a scomparsa incassato lato superiore anta.
Concealed door closure recessed above the door.



- D** Telaio in alluminio anodizzato spessore FISSO 103mm.
Anodised aluminium frame with FIXED thickness of 103 mm.

Sezione Filomuro REI 120_

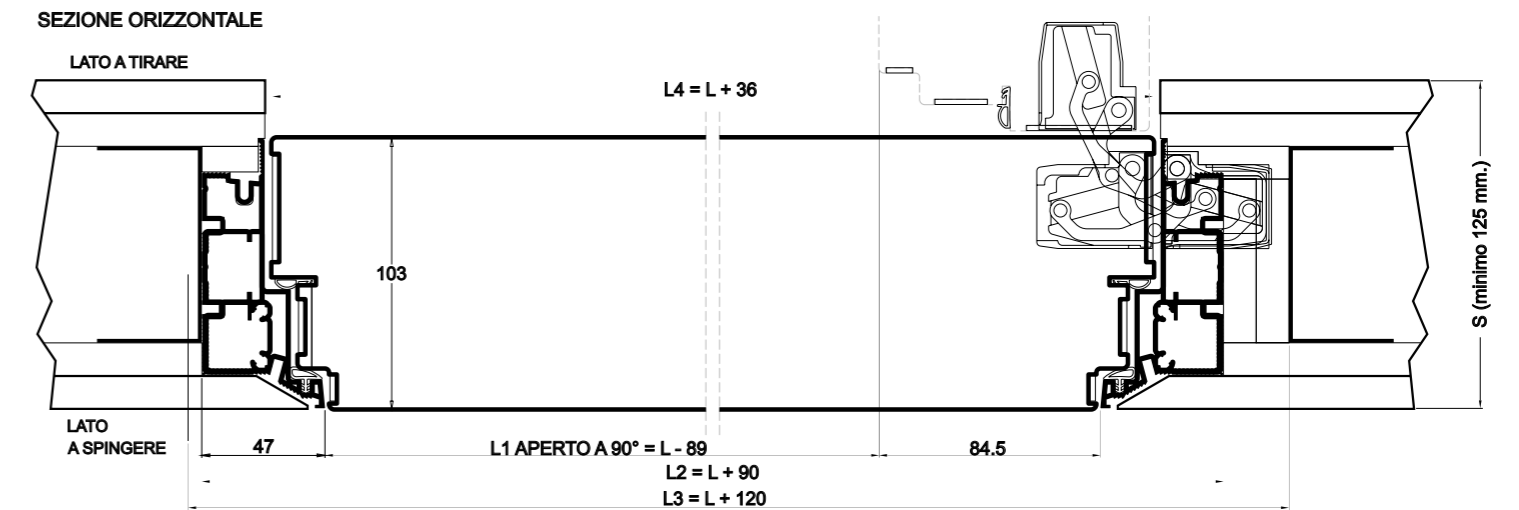

1_ANTA.DOOR.

2_TELAIO.FRAME.

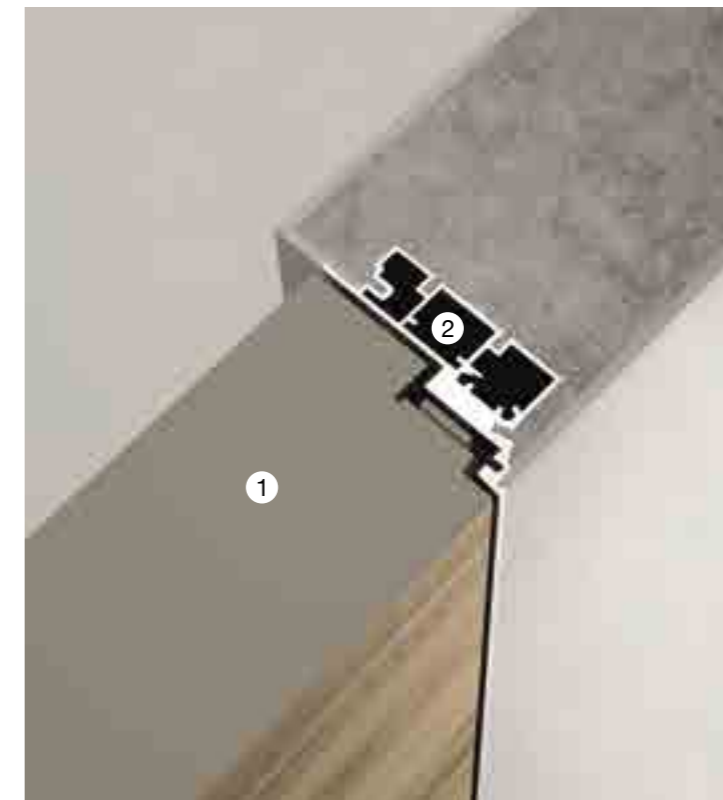

Filomuro REI 120_

INFORMAZIONI TECNICHE TECHNICAL DATA

CARATTERISTICHE E PRESTAZIONI:

Certificata EI60 secondo UNI EN1634-1:2009. Prodotto omologato come da art.1 del D.M. 30/06/2004 dal Ministero dell'Interno con atto di omologazione AN170EI2120P022.

CHARACTERISTICS AND PERFORMANCE:

EI60 certification in accordance with UNI EN1634-1:2009. Product type-approved in accordance with art.1 of M.D. of 30/06/2004 issued by the Ministry of the Interior with type approval act AN170EI2120P022.

FONOSOLANZA

Nessun pacchetto acustico incluso di serie

SOUNDPROOFING

Sound insulation is not included as standard

FINITURE - SERVIZI OPTIONAL (a richiesta con supplemento)

FINISHES - OPTIONAL SERVICES (on request with surcharge)

OBLÒ A VETRO

GLASS PORTHOLE

C1 - FORMA RETTANGOLARE O QUADRATA (superficie max 0,25 mq) con vetro certificato EI 60 trasparente.

C1 - SQUARE OR RECTANGULAR SHAPE (max. surface area 0.25 m²) with transparent glass EI 60 certified.

C2 - FORMA RETTANGOLARE O QUADRATA (superficie max 0,25 mq) con vetro certificato EI 60 sabbiato.

C2 - Rectangular or square (surface max 0.25 m) with glass sandblasted EI 60 certified.

Accessori Accessories

CONSEGNA TELAIO

FRAME DELIVERY

C3 - Gestione anticipata e separata per il solo Telaio.
C3 - Separate production and shipping of the frame.

C4 - Solo telaio 103mm.
C4 - Only 103mm frame.

ESSENZA TELAIO

FRAME ESSENCE

C5 - Solo telaio in finitura laccato opaco tonalità bianco, avorio o tortora Garofoli.
C5 - Frame only with white, ivory or Garofoli light grey matt lacquer finish

C6 - Solo telaio in finitura laccato opaco tonalità RAL.
C6 - Frame only with RAL matt lacquer finish.

C7 - Solo telaio in finitura laccato lucido tonalità bianco, avorio o tortora Garofoli.
C7 - Frame only with white, ivory or Garofoli light grey glossy lacquer finish.

C8 - Solo telaio in finitura laccato lucido tonalità RAL.
C8 - Frame only with RAL glossy lacquer finish.

C9 - Solo telaio in finitura anodizzato nero.
C9 - Frame only with black anodised finish.

KIT FONOSOLANZA

(abbattimento acustico) valido esclusivamente per porta in versione singola.

SOUND INSULATION KIT

(sound insulation) valid exclusively for single door.

D1 - Livello alto 47 ottenuto con guarnizione saliscendi sotto porta + materiale isolante interno "special".
D1 - 42 high level achieved with draught excluder + special insulating material inside.

CONTROPIASTRINO ELETTRICO MAGNETICO

MAGNETIC ELECTRIC STRIKE PLATE

G22 - posizionato sul montante telaio porta lato maniglia, predisposto per essere collegato ad un dispositivo elettronico per lo sblocco dello scrocco maniglia.

G22 - Positioned on the door frame upper on the handle side for connection to an electronic device for releasing the handle latch.

***Per serratura Yale SIC STD magnetica**

*For STD magnetic Yale SIC lock

G23 - posizionato sul montante telaio lato maniglia, predisposto per essere collegato ad un dispositivo elettronico per lo sblocco dello scrocco maniglia

G23 - Positioned on the door frame upper on the handle side for connection to an electronic device for releasing the handle latch

*** Per serratura antipanico OPERA XT o XT DQ**

* For XT or XT DQ OPERA hotel panic lock.



**Accessori, maniglioni
e barre antipanico**

Accessories, large
handles and panic bars



Maniglioni Antipanico Panic Bars

Maniglioni antipanico per porta singola

Panic Bars panic bars for single door

C1 - KIT Maniglione antipanico a barra tipo "ISEO" (tipologia consigliata STD) Attacchi laterali finitura nero, barra finitura rosso (per porta singola posizionato sul lato a spingere della porta). Comprensivo di serratura antipanico DQ con cilindro chiave/chiave.

Foro quadro per entrata maniglia lato a tirare 9 mm.

C1 - KIT for "ISEO" panic bar (type recommended as STD) Side attachments in black, bar in red (for single door positioned on the push side of the door).

Inclusive of DQ panic lock with key/key cylinder.

Square hole for insertion of handle on pull side 9 mm..



C2 - KIT Maniglione antipanico TOUCH BAR tipo "ISEO" attacchi laterali finitura nero, barra finitura rosso (per porta singola posizionato sul lato a spingere della porta). Comprensivo di serratura antipanico DQ con cilindro chiave/chiave.

Foro quadro per entrata maniglia lato a tirare 9 mm.

C2 - KIT for "ISEO" "TOUCH" panic bar with side attachments in black, bar in red (for single door positioned on the push side of the door). Inclusive of DQ panic lock with key/key cylinder.

Square hole for insertion of handle on pull side 9 mm.



C3 - KIT Maniglione antipanico a barra tipo "EXUS" con maniglia anti-infortunistica integrata e serratura antipanico cilindro chiave-chiave. Maniglione con attacchi laterali finitura nero, barra finitura alluminio anodizzato, maniglia in plastica finitura nero (per porta singola, maniglione posizionato sul lato a spingere della porta).

C3 - KIT for "EXUS" panic bar with built-in accident prevention handle and panic lock with key-key cylinder. Large handle with side attachments in black, bar in anodised aluminium, handle in black plastic (for single door, large handle positioned on the push side of the door).



C4 - KIT Maniglione antipanico a barra tipo "EXUS" con maniglia anti-infortunistica integrata e serratura antipanico cilindro chiave-chiave. Maniglione con attacchi laterali finitura cromo lucido, barra finitura alluminio anodizzato, maniglia in finitura alluminio crms. (Per porta singola, maniglione posizionato sul lato a spingere della porta).

C4 - KIT for "EXUS" panic bar with built-in accident prevention handle and panic lock with key-key cylinder. Large handle with side attachments in polished chrome finish, bar in anodised aluminium finish, handle in CRMS aluminium finish. (For single door, large handle positioned on the push side of the door).



C5 - KIT Maniglione antipanico a barra tipo "EXUS" con maniglia anti-infortunistica integrata e serratura antipanico cilindro chiave-chiave. Maniglione con attacchi laterali finitura inox satinato, barra finitura inox satinato, maniglia in finitura inox satinato. (Per porta singola, maniglione posizionato sul lato a spingere della porta).

C5 - KIT for "EXUS" panic bar with built-in accident prevention handle and panic lock with key-key cylinder. Large handle with side attachments in satin stainless steel finish, bar in satin stainless steel finish, handle in satin stainless steel finish. (For single door, large handle positioned on the push side of the door).



C6 - KIT Maniglione antipanico TOUCH BAR tipo "SLASH" con maniglia anti-infortunistica integrata e serratura antipanico cilindro chiave-chiave. Maniglione con attacchi laterali finitura nero, barra finitura alluminio anodizzato, maniglia in plastica finitura nero (per porta singola, maniglione posizionato sul lato a spingere della porta).

C6 - KIT for "SLASH" "touch" panic bar with built-in accident prevention handle and panic lock with key-key cylinder. Large handle with side attachments in black, bar in anodised aluminium, handle in black plastic (for single door, large handle positioned on the push side of the door).



C7 - KIT Maniglione antipanico TOUCH BAR tipo "SLASH" con maniglia anti-infortunistica integrata e serratura antipanico cilindro chiave-chiave. Maniglione con attacchi laterali finitura cromo lucido, barra finitura alluminio anodizzato, maniglia in finitura alluminio crms. (per porta singola, maniglione posizionato sul lato a spingere della porta).

C7 - KIT for "SLASH" "Touch" panic bar with built-in accident prevention handle and panic lock with key-key cylinder. Large handle with side attachments in polished chrome finish, bar in anodised aluminium finish, handle in CRMS aluminium finish. (for single door, large handle positioned on the push side of the door).



C8 - KIT Maniglione antipanico TOUCH BAR tipo "SLASH" con maniglia anti-infortunistica integrata e serratura antipanico cilindro chiave-chiave. Maniglione con attacchi laterali finitura inox satinato, barra finitura inox satinato, maniglia in finitura inox satinato. (per porta singola, maniglione posizionato sul lato a spingere della porta).

C8 - KIT for "SLASH" "Touch" large handle panic bar with built-in accident prevention handle and panic lock with key-key cylinder. Large handle with side attachments in satin stainless steel finish, bar in satin stainless steel finish, handle in satin stainless steel finish. (for single door, large handle positioned on the push side of the door).



Maniglioni antipanico (porta doppia anta apribile + anta semifissa)

Panic bars (double door, opening door + semi-fixed door)

C9 - KIT Maniglione antipanico a barra tipo "ISEO" (tipologia consigliata STD) con sistema paletti interni per blocco anta semifissa. Attacchi laterali finitura nero, barra finitura rosso (per porta singola posizionato sul lato a spingere della porta). Comprensivo di serratura antipanico DQ con cilindro chiave/chiave.

C9 - KIT for "ISEO" panic bar (type recommended as STD) with system of internal pegs for locking the semi-fixed door. Side attachments in black, bar in red (for single door positioned on the push side of the door). Inclusive of DQ panic lock with key/key cylinder.



C10 - KIT Maniglione antipanico TOUCH BAR tipo "ISEO" con sistema paletti interni per blocco anta semifissa. Attacchi laterali finitura nero, barra finitura rosso (per porta singola posizionato sul lato a spingere della porta) comprensivo di serratura antipanico DQ con cilindro chiave/chiave.

C10 - KIT for "ISEO" "Touch" panic bar with system of internal pegs for locking the semi-fixed door. Side attachments in black, bar in red (for single door positioned on the push side of the door) inclusive of DQ panic lock with key/key cylinder



Maniglioni Antipanico Panic Bars

Maniglioni antipanico (porta doppia anta apribile + anta semifissa)

Panic Bars panic bars (double door, opening door + semi-fixed door)

C11 - KIT Maniglione antipanico a barra tipo "EXUS" con maniglia anti-infortunistica integrata e serratura antipanico cilindro chiave-chiave. Sistema paletti interni per blocco semifissa. Maniglione con attacchi laterali finitura nero, barra finitura alluminio anodizzato, maniglia in plastica finitura nero (per porta doppia, maniglione posizionato sul lato a spingere della porta).

C11 - KIT for "EXUS" panic bar with built-in accident prevention handle and panic lock with key-key cylinder. System of internal pegs for locking semi-fixed door. Large handle with side attachments in black, bar in anodised aluminium, handle in black plastic (for double door, large handle positioned on the push side of the door).

C12 - KIT Maniglione antipanico a barra tipo "EXUS" con maniglia anti-infortunistica integrata e serratura antipanico cilindro chiave-chiave. Sistema paletti interni per blocco semifissa. Maniglione con attacchi laterali finitura cromo lucido, barra finitura alluminio anodizzato, maniglia in finitura alluminio crms. (per porta doppia, maniglione posizionato sul lato a spingere della porta).

C12 - KIT for "EXUS" panic bar with built-in accident prevention handle and panic lock with key-key cylinder. System of internal pegs for locking semi-fixed door. Large handle with side attachments in polished chrome finish, bar in anodised aluminium finish, handle in CRMS aluminium finish. (for double door, large handle positioned on the push side of the door).

C13 - KIT Maniglione antipanico a barra tipo "EXUS" con maniglia anti-infortunistica integrata e serratura antipanico cilindro chiave-chiave. Sistema paletti interni per blocco semifissa. Maniglione con attacchi laterali finitura inox satinato, barra finitura inox satinato, maniglia in finitura inox satinato. (per porta doppia, maniglione posizionato sul lato a spingere della porta).

C13 - KIT for "EXUS" panic bar with built-in accident prevention handle and panic lock with key-key cylinder. System of internal pegs for locking semi-fixed door. Large handle with side attachments in satin stainless steel finish, bar in satin stainless steel finish, handle in satin stainless steel finish (for double door, large handle positioned on the push side of the door).

C14 - KIT Maniglione antipanico TOUCH BAR tipo "SLASH" con maniglia anti-infortunistica integrata e serratura antipanico cilindro chiave. Sistema paletti interni per blocco semifissa. Maniglione con attacchi laterali finitura nero, barra finitura alluminio anodizzato, maniglia in plastica finitura nero (per porta doppia, maniglione posizionato sul lato a spingere della porta).

C14 - KIT for "SLASH" "Touch" panic bar with built-in accident prevention handle and panic lock with key cylinder. System of internal pegs for locking semi-fixed door. Large handle with side attachments in black, bar in anodised aluminium, handle in black plastic (for double door, large handle positioned on the push side of the door).

C15 - KIT Maniglione antipanico TOUCH BAR tipo "SLASH" con maniglia anti-infortunistica integrata e serratura antipanico cilindro chiave. Sistema paletti interni per blocco semifissa. Maniglione con attacchi laterali finitura cromo lucido, barra finitura alluminio anodizzato, maniglia in finitura alluminio CRMS. (per porta doppia, maniglione posizionato sul lato a spingere della porta).

C15 - KIT for "SLASH" "Touch" panic bar with built-in accident prevention handle and panic lock with key cylinder. System of internal pegs for locking semi-fixed door. Large handle with side attachments in polished chrome finish, bar in anodised aluminium finish, handle in CRMS aluminium finish. (for double door, large handle positioned on the push side of the door)



C16 - KIT Maniglione antipanico TOUCH BAR tipo "SLASH" con maniglia anti-infortunistica integrata e serratura antipanico cilindro chiave. Sistema paletti interni per blocco semifissa. Maniglione con attacchi laterali finitura inox satinato, barra finitura inox satinato, maniglia in finitura inox satinato. (per porta doppia, maniglione posizionato sul lato a spingere della porta).

C16 - KIT for "SLASH" "Touch" panic bar with built-in accident prevention handle and panic lock with key cylinder. System of internal pegs for locking semi-fixed door. Large handle with side attachments in satin stainless steel finish, bar in satin stainless steel finish, finish handle in satin stainless steel finish (for double door, large handle positioned on the push side of the door).



Maniglioni antipanico per porta singola. Maniglione posizionato sul lato a spingere della porta.

Panic bars for single door. Large handle positioned on the push side of the door.

C17 - KIT Maniglione antipanico a barra tipo "CISA" (SOLO PER STILIAREI30) Attacchi laterali finitura nero, barra finitura rosso (per porta singola posizionato sul lato a spingere della porta). Comprensivo di serratura antipanico DQ con cilindro chiave/chave.

C17 - KIT for "CISA" panic bar (ONLY FOR STILIAREI30) Side attachments in black, bar in red (for single door positioned on the push side of the door). Inclusive of DQ panic lock with key/key cylinder.



C18 - KIT Maniglione antipanico TOUCH BAR tipo "CISA" (SOLO PER STILIAREI30) Attacchi laterali finitura nero, barra finitura rosso (per porta singola posizionato sul lato a spingere della porta). Comprensivo di serratura antipanico DQ con cilindro chiave/chave.

C18 - KIT for "CISA" "Touch" panic bar (ONLY FOR STILIAREI30) Side attachments in black, bar in red (for single door positioned on the push side of the door). Inclusive of DQ panic lock with key/key cylinder.



Maniglioni antipanico per porta doppia anta apribile + anta semifissa). Maniglione posizionato sul lato a spingere della porta.

Panic bars for double door, opening door + semi-fixed door. Large handle positioned on the push side of the door.

C19 - KIT Maniglione antipanico a barra tipo "CISA" (SOLO PER STILIAREI30) con sistema paletti esterni a vista per blocco anta semifissa. Attacchi laterali finitura nero, barra finitura rosso (per porta doppia posizionato sul lato a spingere della porta) Comprensivo di serratura antipanico DQ con cilindro chiave/chave.

C19 - C19 - KIT for "CISA" "Touch" panic bar (ONLY FOR STILIAREI30) with system of visible external pegs for locking the semi-fixed door. Side attachments in black, bar in red (for double door, positioned on the push side of the door). Inclusive of DQ panic lock with key/key cylinder.



Maniglioni Antipanico Panic bars

Maniglioni antipanico per porta doppia anta apribile + anta semifissa). Maniglione posizionato sul lato a spingere della porta.

Panic bars for double door, opening door + semi-fixed door. Large handle positioned on the push side of the door.

C20 - KIT Maniglione antipanico TOUCH BAR tipo "CISA" (SOLO PER STILIA REI30) con sistema paletti esterni a vista per blocco anta semifissa. Attacchi laterali finitura nero, barra finitura rosso (per porta singola posizionato sul lato a spingere della porta). Comprensivo di serratura antipanico DQ con cilindro chiave/chiave.

C20 - KIT for "CISA" "Touch" panic bar (ONLY FOR STILIA REI30) with system of visible external pegs for locking the semi-fixed door. Side attachments in black, bar in red (for single door positioned on the push side of the door). Inclusive of DQ panic lock with key/key cylinder.



Pomolo e Maniglia Knob and handle

Kit completo (pomolo fisso esterno + maniglia lato interno)

Complete kit (external fixed knob + internal handle)

D1 - KIT REI TOP - Pomolo fisso (Pegaso) + maniglia interna (Golf).
D1 - REI TOP KIT - Fixed knob (Pegaso) + internal handle (Golf).

D2 - KIT REI MILENA - Pomolo fisso (Pegaso) + maniglia interna (Milena).
D2 - REI MILENA KIT - Fixed knob (Pegaso) + internal handle (Milena).

D3 - KIT SQUADRA DECENTRATO - Pomolo fisso (Squadra decentrato) + maniglia interna (Squadra).
D3 - SQUADRA DECENTRATO KIT - Fixed knob (Squadra decentrato) + internal handle (Squadra).

D4 - KIT ICE - Pomolo fisso (Quattro) + maniglia interna (Ice 2018).
D3 - ICE KIT - Fixed knob (Quattro) + internal handle (Ice 2018).

D6 - KIT HOTEL LUCE - Pomolo fisso (Fluò) + maniglia interna (Luce).
D6 - HOTEL LUCE KIT - Fixed knob (Fluò) + internal handle (Luce).

D8 - KIT DOLLY - Pomolo fisso (Svezia) + maniglia interna (Dolly).
D8 - DOLLY KIT - Fixed knob (Svezia) + internal handle (Dolly).

D9 - KIT HOTEL AMBRA - Pomolo fisso (Tondo) + maniglia interna (Ambra).
D9 - HOTEL AMBRA KIT - Fixed knob (Tondo) + internal handle (Ambra).



Pomolo e Maniglia Knob and handle

Kit completo (pomolo fisso esterno + maniglia lato interno)

Complete kit (external fixed knob + internal handle)

D10 - KIT HOTEL AMBRA - Pomolo fisso (Rondò) + maniglia interna (Ambra).
D10 - HOTEL AMBRA KIT - Fixed knob (Rondò) + internal handle (Ambra).

D11 - KIT SMART - Pomolo fisso (Squadra decentrato) + maniglia interna (Smart).
D11 - SMART KIT - Fixed knob (Squadra decentrato) + internal handle (Smart).

D12 - KIT WING - Pomolo fisso (Wing) + maniglia interna (Wing).
D12 - WING KIT - Fixed knob (Wing) + internal handle (Wing).

D13 - KIT FRAME - Pomolo fisso (Frame) + maniglia lato interna (Frame).
D13 - FRAME KIT - Fixed knob (Frame) + internal handle (Frame).

D14 - KIT YORK - Pomolo fisso (Frame) + maniglia interna (York).
D14 - KIT YORK - Fixed knob (Frame) + internal handle (York).



Maniglie per porte battenti

Swing doors handles

E1 - 110&LODE
"Barocco"
E1 - 110 LODE
"Baroque"



E2 - 110&LODE
"decapè"
E2 - 110 LODE
"pickled"



E3 - 110&LODE
"LISCIA"
E3 - 110 LODE
"SMOOTH"



E4 - Ambra
E4 - Ambra



E6 - Ambra
allungata
E6 - Ambra
elongated



E7 - Area 51
E7 - Area 51



E9 - Atlanta
E9 - Atlanta



E13 - Base
E13 - Base



E15 - Blade
E15 - Blade



E16 - Bolt
E16 - Bolt



E19 - Bolt Wood
E19 - Bolt Wood



E22 - Classica
E22 - Classica



E23 - Due
E23 - Due



E24 - Dolly
E24 - Dolly



E25 - Eidos
E25 - Eidos



Pomolo e Maniglia

Knob and handle



Maniglioni fissi

Fixed large handles

Maniglione fisso (singolo solo un lato)
Fixed large handle (single, one side only)

F1 - Modello DRITTO
(disponibile nelle finiture ottone lucido, cromo lucido e cromo satinato)
F1 - DRITTO Model
(available in finishes: polished brass, polished chrome and satin chrome)

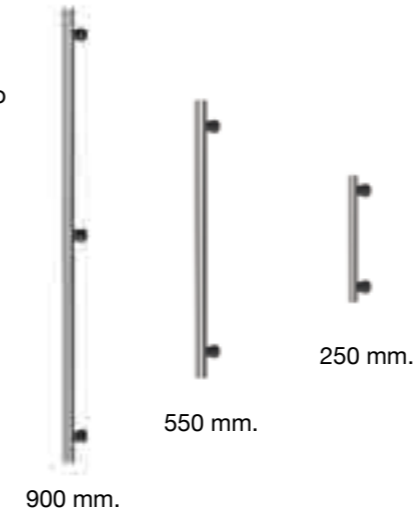

F4 - Modello CURVO
(disponibile nelle finiture ottone lucido, cromo lucido e cromo satinato)
F4 - CURVO Model
(available in finishes: polished brass, polished chrome and satin chrome)



F7 - Modello SIRIO
squadrate (disponibile nella finitura bicolore: impugnatura cromo satinato e attacchi cromo lucido).
F7 - Square SIRIO model square (available in two-tone finishes: satin chrome grip and polished chrome attachments).

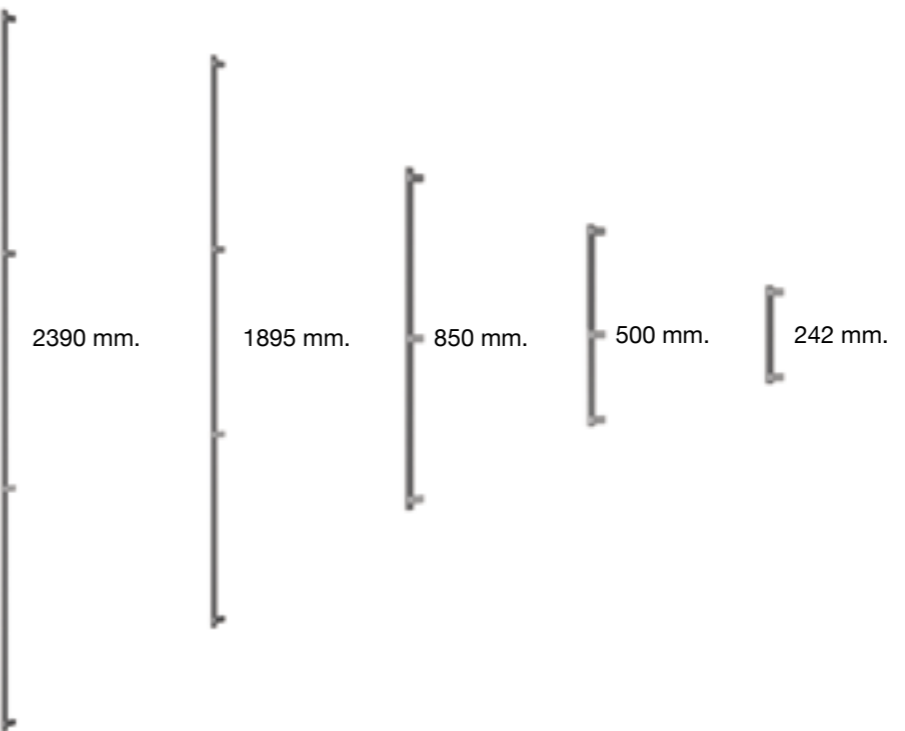

Maniglioni fissi

Fixed large handles

Maniglione fisso (singolo solo un lato)
Fixed large handle (single, one side only)

F12 - Modello AREA51
(disponibile nelle finiture cromo lucido, cromo satinato e bianco opaco)

F12 - AREA51 model
(available in finishes: polished chrome, satin chrome and matt white)

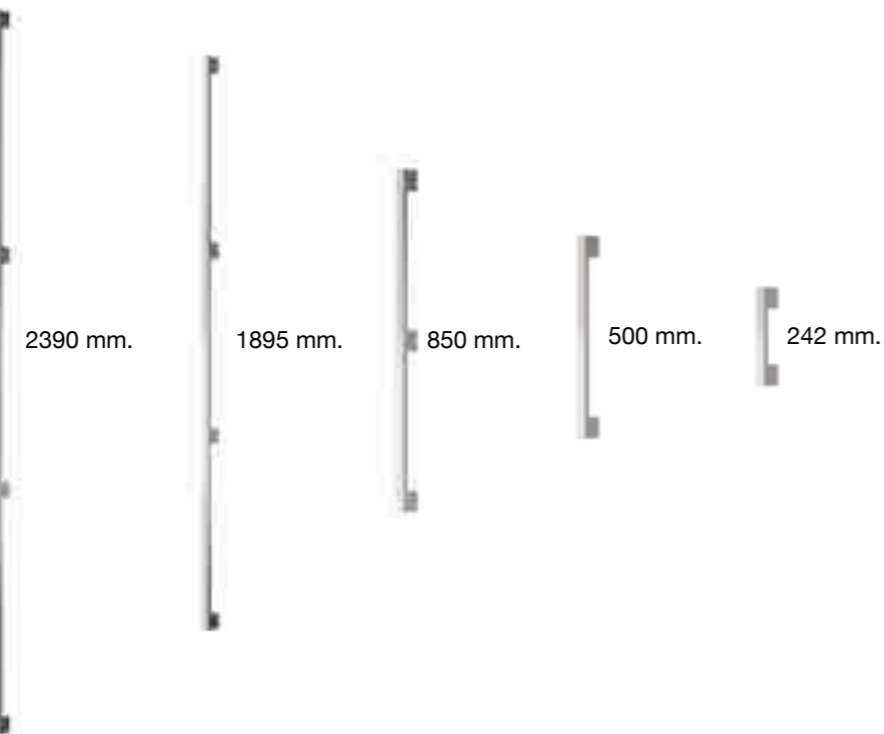

Maniglie anti-infortunistiche
Accident prevention handles



G1 - Modello FREEN 1000 squadrato (disponibile nelle finiture cromo lucido, cromo satinato).
G1 - FREEN 1000 model, square (available in finishes: polished chrome, satin chrome).

*** Consigliato in versione:**

- impugnatura 200 mm
- Toilet
- Altezza ribassata H. 900 mm da terra per portatori di Handicap.

*** Recommended version:**

- 200 mm length
- Toilet
- Reduced high: 900 mm from floor for disabled people.



G2 - Coppia maniglia (interna ed esterna) modello AMBRA

* Nota - Consigliata per portatori di handicap in versione:

- impugnatura 200 mm
- toilet
- altezza ribassata h=900mm da terra

G2 - Handle pair (internal and external) AMBRA model.

* Note: recommended version for disabled people:

- 200 mm length
- Toilet
- Reduced high: 900 mm from floor.



G4 - Maniglia modello NINZ INOX
G4 - NINZ INOX model handle



G5 - Maniglia modello NINZ NERO
G5 - NINZ NERO model handle

Kit serrature elettronica

Electronic lock Kit

KIT APERTURA ELETTRONICA CON BADGE "OPERA BIT"
"OPERA BIT" ELECTRONIC OPENING KIT WITH BADGE

Kit con serratura elettronica per Hotel con movimento magnetico.

- Opera Bit offre la libertà di scegliere la maniglia, infatti può essere abbinata a qualsiasi classico modello di maniglia.
- Opera Bit ha un design minimale grazie al lettore e al porta-batterie incredibilmente piccoli; con la finitura delle cover personalizzabile.
- La serratura ha lo scrocco a movimento magnetico che scompare ad anta aperta. Il catenaccio automatico di Opera Bit fuoriesce alla chiusura dell'anta garantendo massima sicurezza all'ospite che non dovrà mai ricordarsi di chiudere la porta a chiave, sia all'ingresso che all'uscita dalla camera.
- Ha il pulsante di privacy: Do not disturb.
- Con la serratura antipanico, dall'interno della camera, abbassando la maniglia si sbloccano all'istante il catenaccio e lo scrocco per un'apertura immediata della porta.
- In caso di emergenza si può sbloccare la maniglia usando il cilindro meccanico garantendo l'apertura manuale della porta.
- Il sistema Stand Alone è semplice da utilizzare: basta l'ausilio di un solo computer e il dispositivo per la scrittura delle tessere; per impianti di dimensioni ridotte può addirittura essere gestito totalmente con le sole tessere pre-configurate.
- Il sistema è completo e flessibile con gestione differente per i clienti e gli operatori dell'hotel. Senza nessun limite al numero di utenti gestibili e di serrature.
- Ogni serratura conserva lo storico degli ultimi 1.000 accessi. Il software è compatibile con tutti i sistemi operativi e può essere interfacciato con applicazioni di terze parti (software gestionali e sistemi di automazione della camera). Il software per la programmazione e gestione dell'impianto e degli operatori è in grado di gestire anche i sistemi più complessi.
- Opera Bit Check-In è il software per il check-In e check-Out dei clienti e la creazione delle loro tessere. Il modulo è dotato di un'interfaccia user-friendly e può facilmente essere usato senza rischi anche da operatori che non possiedono alcuna competenza informatica.

Electronic lock kit with magnetic movement for hotels.

- Opera Bit offers you the freedom of being able to choose the handle. It can be combined with any common handle model.
- Opera Bit has a minimalist design thanks to its incredibly small reader and battery holder; with customisable cover.
- The lock features a latch with magnetic movement that is concealed at the door opening. The automatic chain supplied with Opera Bit comes out as the door closes, this provides maximum security for guests, meaning that they never have to remember to lock the door, both when entering or leaving the room.
- Has a privacy button: Do not disturb.
- With the panic lock, when the handle is lowered from inside the room, the chain and latch are released immediately for instant opening of the door.
- In the event of an emergency the handle can be released using the mechanical cylinder, ensuring manual door opening.
- The stand alone system is easy to use: all that is required is a single computer and the card writing device; small systems can be managed completely using only the pre-configured cards.
- The system is complete and flexible, with differentiated management for customers and hotel staff. There is no limit to the number of users, and even the number of locks that can be managed is unlimited.
- Each lock stores an archive of the last 1000 accesses. The software is compatible with all operating systems and can be interfaced with third party applications (management software and room automation systems). The programming, system management and user software is also able to manage even the most complex systems.
- Opera Bit Check-In is the software for customer check-in and check-out and for card creation. The module has a user-friendly interface and can easily be used by users with no knowledge of computer systems.

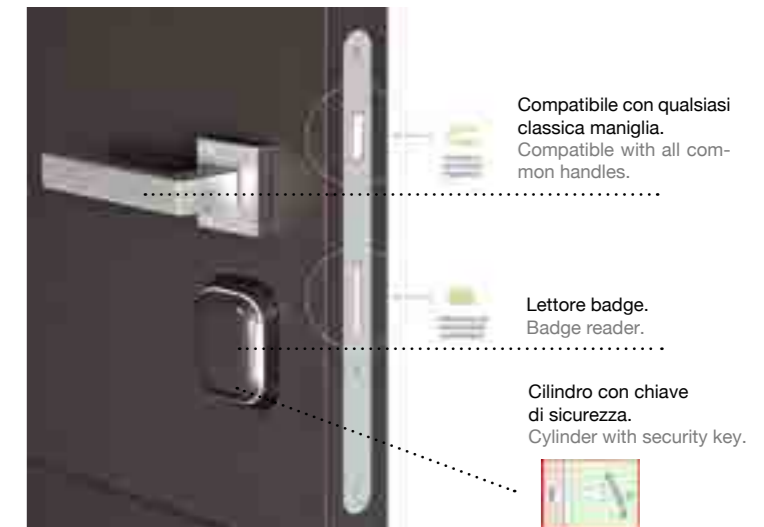

Il catenaccio esce automaticamente alla chiusura dell'anta. Garantisce massima sicurezza all'ospite che non dovrà mai ricordarsi di chiudere la porta a chiave.

The latch comes out automatically when the door is closed. This provides maximum security for guests meaning that they never have to remember to lock the door.



Il pulsante di privacy permette agli utilizzatori della camera di non essere disturbati. Infatti con la funzione "do not disturb" attivata, l'accesso al personale di servizio è bloccato.

The privacy button allows users to ensure they are not disturbed. When the "do not disturb" function is active, access for cleaning staff is denied.



Serratura antipanico: dall'interno della camera, abbassando la maniglia, si sblocca automaticamente la chiusura, permettendo l'apertura immediata della porta.

Panic lock: when the handle is lowered from inside the room, the lock is automatically released, allowing the door to be opened immediately.

Kit serrature elettronica e Maniglia

Electronic lock and handle Kit

KIT APERTURA ELETTRONICA CON BADGE "OPERA BIT" VERSIONE "SPRINT"
 "OPERA BIT" ELECTRONIC OPENING KIT WITH BADGE "SPRINT" VERSION

Opera Bit
 Versione SPRINT



K1 - Kit: serratura + cilindro + lettore a placca quadrata + 2 cards chiave (maniglia standard esclusa), (batterie stilo AA escluse).

K1 - Kit: lock + cylinder + square plate reader + 2 key cards (standard handle excluded), (AA batteries excluded).

La semplicità in funzione



1
Avvicinare al lettore la Tessera di Attivazione.



2
Il lettore inizia a lampeggiare. Avvicinare una nuova tessera.



3
La tessera è ora autorizzata all'apertura della porta.



K3 - Optional. Energy Saver, lettore a muro per accensione della luce all'interno camera, azionabile sempre tramite cards

K3 - Optional Energy Saver, wall-mounted reader for switching on the light inside the room, which can be operated using the cards



K4 - Optional. Kit lettore da parete + modulo di controllo Lettore da parete per l'attivazione di dispositivi da integrare ad un impianto Opera Bit (es.tornelli, sbarre, ecc.).

K4 - Optional. Kit with wall reader + Wall reader control module for activating devices to be integrated into an Opera Bit system (e.g. turnstiles, bars, etc.).



K5 - Optional. Batterie stilo AA 1,5 V disponibile in confezione da 10 pz.

K5 - Optional. 1.5V AA batteries available in pack of 10.



K6 - Optional. Eventuali cards (1kbyte) aggiuntive con grafica standard "opera bit".

K6 - Optional. Extras. Extra cards (1kbyte) with standard "opera bit" graphics.

K7 - Optional. Eventuale Impianto Grafico Personalizzato (logo)

K7 - Optional. Customised Graphics (logo)

Kit serrature elettronica

Electronic lock Kit

KIT APERTURA ELETTRONICA CON BADGE "OPERA BIT" VERSIONE "FULL"
 (lettore disponibile nelle finiture bianco, grigio opaco o nero con serratura in cromo satinato o ottone)
 "OPERA BIT" ELECTRONIC OPENING KIT WITH BADGE "FULL" VERSION
 (reader also available in white, matt grey or black with lock in satin finish chrome or brass)

Opera Bit
 Versione FULL



K8 - Kit: serratura + cilindro + lettore a placca quadrata + 2 cards chiave (maniglia standard esclusa), (batterie stilo AA escluse).

K8 - Kit: lock + cylinder + square plate reader + 2 key cards (standard handle excluded), (AA batteries excluded).

K9 - Vidamatore per cards, necessario almeno un articolo a fornitura

K9 - Card reader, at least one item required per supply.



K10 - Software "Opera Bit Full" hotel, programma per la logistica e controllo del sistema

K10 - "Opera Bit Full" hotel software, program for logistics and system control



K13 - Set di avviamento a sistema FULL (tessera per l'attivazione + guida di installazione + guida utente). Necessario almeno 1kit a fornitura

K13 - Starting kit for FULL system (activation card + installation guide + user guide). At least 1 kit is required per supply



K14 - Optional. Energy Saver, lettore a muro per accensione della luce all'interno camera, azionabile sempre tramite cards

K14 - Optional. Energy Saver, wall-mounted reader for switching on the light inside the room, which can be operated using the cards



K15 - Optional. Kit lettore da parete + modulo di controllo Lettore da parete per l'attivazione di dispositivi da integrare ad un impianto Opera Bit (es.tornelli, sbarre, ecc.).

K15 - Optional. Kit with wall reader + Wall reader control module for activating devices to be integrated into an Opera Bit system (e.g. turnstiles, bars, etc.).



K16 - Optional. Batterie stilo AA 1,5 V disponibile in confezione da 10 pz.

K16 - Optional. 1.5V AA batteries available in pack of 10.



K17 - Optional. Eventuali cards (1kbyte) aggiuntive con grafica standard "opera bit".

K17 - Optional extras. Extra cards (1kbyte) with standard "opera bit" graphics.

K18 - Optional. Eventuale Impianto Grafico Personalizzato (logo)

K18 - Optional. Customised Graphics (logo)

Kit serrature elettronica

Electronic lock Kit

KIT APERTURA ELETTRONICA CON BADGE "OPERA iControl"
"OPERA iControl" ELECTRONIC OPENING KIT WITH BADGE

Opera iControl

SERRATURA ELETTRONICA PER HOTEL



La chiusura perfetta per chi già possiede un sistema di controllo accessi



Compatibile con ogni sistema di lettore a muro



Sicurezza, design e silenziosità per la porta



La chiusura perfetta per integrarsi con un sistema di controllo accessi (RMS)

Opera iControl funziona come un riscontro elettrico, ma in più garantisce alla tua porta:

più DESIGN



Libertà di scegliere la maniglia.



Frontale della serratura minimal e scrocco non sporgente.



L'incontro è unico per porte sia destre che sinistre, senza aletta.

più SICUREZZA



Scrocco magnetico e catenaccio automatico per massima sicurezza antieffrazione.



Il catenaccio in acciaio sinterizzato protegge la camera dai tentativi di effrazione.



Il mezzo cilindro meccanico di emergenza garantisce l'apertura manuale della porta.

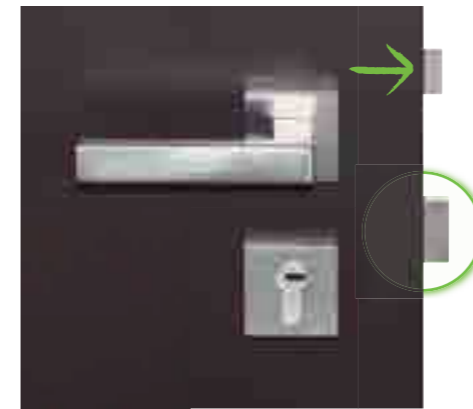

Twin Lock

Il sistema TWIN LOCK protegge la sicurezza della tua camera.

Lo scrocco magnetico ① fuoriesce non appena l'anta si appoggia al telaio e il catenaccio automatico ② si aziona garantendo la massima sicurezza antieffrazione.

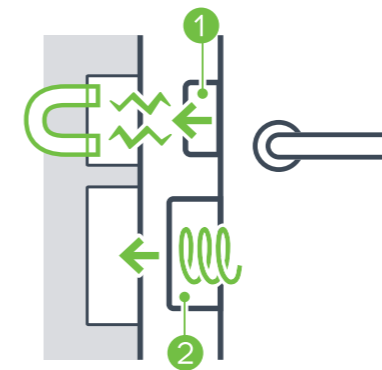

Lo scrocco a movimento magnetico ridefinisce gli standard di silenziosità quando l'anta chiude.



Catenaccio automatico di serie

Il catenaccio fuoriesce automaticamente alla chiusura dell'anta. Garantisce massima sicurezza all'ospite che non dovrà mai ricordarsi di chiudere la porta a chiave.

A prova d'urto



La particolare lavorazione del catenaccio in acciaio sinterizzato ne garantisce grande resistenza agli urti.

Efficacia antieffrazione

Il catenaccio protegge la camera dai tentativi di effrazione con destrezza con schede, ma anche dai tentativi di scasso forzando la porta con degli utensili.



Serratura antipanico

Dall'interno della camera, abbassando la maniglia, si sbloccano all'istante il catenaccio e lo scrocco per un'apertura immediata della porta.

Cilindro di emergenza, una carta in più



Anche nelle serrature elettroniche, la presenza del cilindro meccanico di serie garantisce l'apertura manuale della porta.

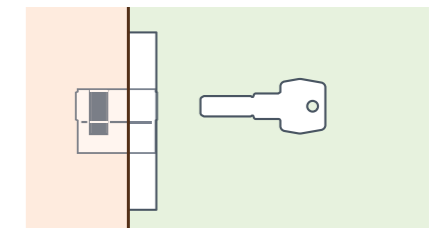

L1 - Kit: serratura + cilindro
- maniglia standard classica esclusa
- batterie stilo AA escluse
- lettore badge a muro escluso

L1 - Kit: lock + cylinder
- classic standard handle excluded
- AA batteries excluded
- wall badge reader excluded



K16 - Optional. Batterie stilo AA 1,5 V disponibile in confezione da 10 pz.

K16 - Optional. 1.5V AA batteries available in pack of 10.

Accessori

Accessories

M1 - SPIONCINO/OCCHIO MAGICO (disponibile nelle finiture cromo o ottone)
M1 - SPY HOLE/DOOR VIEWER (also available in chrome or brass)



M2 - LAMA TAGLIA - FREDDO. Guarnizione sali-scendi sotto porta. disponibile per tutte le porte REI.
(Di serie già presente nei kit acustici)

M2 - DRAUGHT EXCLUDER. Sliding seal below door. Available for all REI doors. (Provided as standard with sound insulation)



M3 - PLACCHE PARA COLPI PER PORTA BATTENTE IN ACCIAIO INOX SPAZZOLATO

Disponibile per posizionamento parte inferiore anta. Misure (H 200 mm) x L (larghezza anta) x spessore 2 mm.

M3 - PROTECTIVE PLATES FOR HINGED DOOR IN BRUSHED STAINLESS STEEL

Available for positioning on lower part of door. Measurements (H 200 mm) x W (door width) x thickness 2 mm.



M4 - FERMA-PORTA (meccanismo per il blocco e rilascio automatico-elettromagnetico delle ante)

M4 - DOOR STOP (mechanism for automatic-electromagnetic locking and releasing of the doors)



M5 - SENSORE STATO PORTA Sensore per rilevare lo stato di apertura / presenza porta

M5 - DOOR STATUS SENSOR Sensor to detect door open / closed



M6 - Limitatore di apertura per porte a battente "stop a terra" mod. CILINDRICO:
(disponibile nelle finiture cromo lucido, cromo satinato e ottone lucido)

M6 - Opening limiter for "floor stop" hinged doors model CILINDRICO:
(available in polished chrome, satin finish chrome and polished brass)



M7 - Limitatore di apertura per porta a battente "stop a terra" mod. CHIOCCIOLA:
(disponibile nelle finiture cromo lucido, cromo satinato e ottone lucido)

M7 - Opening limiter for "floor stop" hinged doors model CHIOCCIOLA:
(available in polished chrome, satin finish chrome and polished brass)



M8 - Limitatore di apertura per porta battente "stop a terra" mod. MAGNETICO:
(disponibile nelle finiture cromo)

M8 - Opening limiter for "floor stop" hinged doors model MAGNETICO:
(available in chrome finishes)



M9 - Limitatore di apertura per porta battente "stop a muro" con appendi abiti mod. STOP WALL:
disponibile nella finitura cromo (Dimensioni L = 84 mm con circonferenza attacco 45 m)

M9 - Opening limiter for "wall stop" hinged doors with coat hangers model STOP WALL:
available in chrome finish (Dimensions W = 84 mm with attachment circumference 45 m)



M10 - Limitatore di apertura per porta battente "stop su maniglia" mod. SALVAMANIGLIA:
disponibile nella finitura cromo (Dimensioni L = 84 mm con circonferenza attacco 45 m)

M10 - Opening limiter for "handle stop" hinged doors model SALVAMANIGLIA:
available in chrome finish (Dimensions W = 84 mm with attachment circumference 45 m)



M11 - TARGHE SU PORTE PER IDENTIFICAZIONE AMBIENTI

M11 - DOOR PLATES FOR ROOM IDENTIFICATION

Modello **SQUADRATO** a caratteri singoli (numeri o lettere) disponibile in finitura inox. Numeri con dimensioni 70x80 mm da 0 a 9. Lettere con dimensioni 60x70 mm da A a Z. Fissaggio tramite biadesivo pre-incollato sul retro.

SQUARE model with single characters (numbers or letters) available in stainless steel finish. Numbers sized 70x80 mm from 0 to 9. Letters sized 60x70 mm from A to Z. Fastening via double-sided adhesive on back.



Optional dima di posizionamento per numeri e lettere mod. **SQUADRATO** (3 posizioni) in acciaio

Optional positioning template for numbers and letters model SQUADRATO (3 positions) in steel



Modello **CLASSICO OVALE** a placca di forma ovale con incisione (lettere o numeri), disponibile in finitura cromo satinato, cromo lucido o ottone lucido. Placca dimensioni esterne 130x75mm, scrittura H 15mm. Fissaggio tramite collante sul retro.

CLASSICO OVALE model oval plate with engraving (letters or numbers), available in satin finish chrome, polished chrome or polished brass. External dimensions of plate 130x75mm, writing H 15mm. Fastening via adhesive on back.



Modello **CLASSICO RETTANGOLARE** a placca di forma rettangolare con incisione (lettere o numeri), disponibile in finitura cromo satinato, cromo lucido o ottone lucido. Placca dimensioni esterne 130x75mm, scrittura H 15mm. Fissaggio tramite collante sul retro.

CLASSICO RETTANGOLARE model rectangular plate with engraving (letters or numbers), available in satin finish chrome, polished chrome or polished brass. External dimensions of plate 130x75mm, writing H 15mm. Fastening via adhesive on back.



Modello **PITTOGRAMMA** targhetta rotonda con pittogramma (uomo, donna, wc o disabili) disponibile in finitura inox. Targhette circolari di diametro 75 mm con 4 indicazioni disponibili. Fissaggio tramite biadesivo pre-incollato sul retro.

PITTOGRAMMA model round plate with pictogram (man, woman, WC or disabled), available in stainless steel finish. Circular plates 75 mm in diameter with 4 indications available. Fastening via double-sided adhesive on back.



Scarica i cataloghi dei prodotti Garofoli coordinabili

Download the catalogs of coordinated Garofoli products.

Garofoli Parquet
Garofoli Parquet



Battiscopa
Filomuro Garofoli
Garofoli Filomuro
Skirting



Garofoli Boiserie
Garofoli Boiserie



Garofoli Armadi
e sistemi Miria
Garofoli Miria
Wardrobes and
systems



Certificati REI

REI Certificates

	Italy Spain 	France 	United Kingdom 	United States 	Russia 	Croatia 	Canada 	Germany Switzerland
	Included in the basic price Incluso nel prezzo base porta	Extra charge of: (certificate) + 80€ each door Supplemento: + 80€ a porta	Included in the basic price Incluso nel prezzo base porta	Extra charge of: (UL certificate) + 140€ each door Supplemento: +140€ e a porta	Included in the basic price Incluso nel prezzo base porta	Included in the basic price Incluso nel prezzo base porta	Extra charge of: (UL certificate) + 140€ each door Supplemento: +140€ e a porta	Ask for quotation. Extra charge. Richiedere Preventivo. Supplemento.
Stilia Rei 30	El certificate (30 min.) 	El certificate (30 min.) 	El certificate (30 min.) 	El certificate (20 min. and 30 min.) 	El certificate (30 min.) 		El certificate (30 min.) 	
Timber Rei 30	El certificate (30 min.) 				El certificate (30 min.) 	El certificate (30 min.) 		
Filomuro Rei 30	El certificate (30 min.) 			El certificate (30 min.) 			El certificate (30 min.) 	
Poema Rei 30	El certificate (30 min.) 			El certificate (30 min.) 			El certificate (30 min.) 	
Plania Rei 60	El certificate (60 min.) 				El certificate collection FiloREI45 (60 min.) 			
Gdesign Rei 60	El certificate (60 min.) 	El certificate (60 min.) 	El certificate (60 min.) 		El certificate (60 min.) 			
Gold Rei 60	El certificate (60 min.) 		El certificate (60 min.) 					
Filomuro Rei 60	El certificate (60 min.) 		El certificate (60 min.) 	El certificate (45 min.) 	El certificate (60 min.) 		El certificate (45 min.) 	
Rei 120	El certificate (120 min.) 							
Filomuro Rei 120	El certificate (120 min.) 							

Reference List Selection

HOSPITALITY

Sofitel Tamuda Bay, 2016, Marocco
 Mandarin Oriental Hotel, 2015, Milano
 Profumo Maison D'hotels, 2017, Roma
 Sasso Resort, 2010, Villa Brozzi (TE)
 Hotel Melia, 2016, Parigi
 Residence 5:28, Cancun (Messico)
 Le Rubic, Montreal (Canada)
 Signature Ice Elm, Ciudad de Panama (Panama)
 Hotel Martin, Medjugorje (Bosnia)
 La Fayette, Parigi

RESIDENTIAL

Iset Tower Residence, Ekaterinburg (Russia)
 Barkli Park Residence, Mosca
 Frunzenskaya Residence, Mosca
 Tannenbaum Project, Miami (Florida)
 Residence Fontana, Teplice (Repubblica Ceca)

PUBLIC AREAS

Stadium Otkritie, Mosca
 Lukoil Central Office, Mosca
 El Sol Sureno, Wi (Barbados)
 Regal Building, Santo Domingo
 Prestige, Londra

BUSINESS SPACES

Opificio Salpi, 2016, Preci (PG)
 Fondazione Prada, 2016, Milano
 Stabilimento Philip Morris, 2015, Crespellano (BO)
 Bank Otkritie, Mosca

SPECIAL PROJECTS AND RETAIL

Alitalia, 2016, Fiumicino (Roma)
 Evolution Tower, 2015, Mosca
 Theatre of Tobolsk, Tobolsk (Russia)
 Cern, Ginevra (Svizzera)
 Kasalta Project, 2018, Curaçao



WE.ME Suite Hotel - 2020 - Riccione (Rimini) - Hospitality



WE.ME Suite Hotel - 2020 - Riccione (Rimini) - Hospitality



Campus Zambon - 2019 - Bresso (Milano) - Special Projects



Campus Zambon - 2019 - Bresso (Milano) - Special Projects



Campus Zambon - 2019 - Bresso (Milano) - Special Projects



Giardini d'inverno - 2019 - Milano - Hospitality



Giardini d'inverno - 2019 - Milano - Hospitality



Torre Galfa - 2019 - Milano - Residential



Torre Galfa - 2019 - Milano - Residential



Torre Galfa - 2019 - Milano - Residential



Headquarter Amazon Italia - 2018 - Milano - Commercial Spaces



Headquarter Amazon Italia - 2018 - Milano - Commercial Spaces



Headquarter Amazon Italia - 2018 - Milano - Commercial Spaces



Studentato Santa Marta - 2018 - Venezia - Special Projects



Studentato Santa Marta - 2018 - Venezia - Special Projects

CERTIFICAZIONI | CERTIFICATIONS | CERTIFICATIONS | CERTIFICACIONES | ZERTIFIZIERUNGEN | СЕРТИФИКАТЫ

Il Gruppo Garofoli ha sempre mirato alla qualità, promuovendo lo sviluppo sostenibile delle proprie attività e perseguendo una decisa politica ambientale. Una filosofia che ha portato al raggiungimento di importanti traguardi.

- › 2001_ **ISO 9001** Sistema di gestione della qualità.
- › 2009_ **ISO 14001** Sistema di gestione ambientale.
- › 2009_ **COC/PEFC™** Program for endorsement of forest certification schemes, lo schema più diffuso e famoso al mondo per la gestione sostenibile delle foreste.
- › 2010_ **OHSAS 18001** Sistema di gestione per la sicurezza e salute sui luoghi di lavoro.
- › 2015_ **FSC Forest Stewardship Council: Forest For All Forever: www.ic.fsc.org**

The **Garofoli Group** has always aimed at quality, promoting the sustainable development of its business activities and pursuing a strong environmental policy. A philosophy which has resulted in the attainment of important goals.

- › 2001_ **ISO 9001** Quality management system.
- › 2009_ **ISO 14001** Environmental management system.
- › 2009_ **COC/PEFC™** Certification program for endorsement of forest certification schemes, the most widespread and renown scheme in the world for sustainable forest management.
- › 2010_ **OHSAS 18001** Certification management system for occupational health and safety.
- › 2015_ **FSC Forest Stewardship Council: Forest For All Forever: www.ic.fsc.org**

Le **Groupe Garofoli** a toujours recherché la qualité, promouvant le développement durable de ses activités et poursuivant une politique environnementale claire. Une philosophie qui a permis d'atteindre des objectifs majeurs.

- › 2001_ **ISO 9001** Système de management de la qualité.
- › 2009_ **ISO 14001** Système de management environnemental.
- › 2009_ **COC/PEFC™** Program for endorsement of forest certification schemes, le système de certification le plus répandu et connu au monde pour la gestion durable des forêts.
- › 2010_ **OHSAS 18001** Système de gestion de la santé et de la sécurité au travail.
- › 2015_ **FSC Forest Stewardship Council: Forest For All Forever: www.ic.fsc.org**

El **Grupo Garofoli** persigue desde siempre la calidad, promoviendo el desarrollo sostenible de sus actividades y adoptando una específica política ecológica. Esta filosofía lo ha llevado a alcanzar importantes objetivos.

- › 2001_ **ISO 9001** Sistema de gestión de la calidad.
- › 2009_ **ISO 14001** Sistema de gestión medioambiental.
- › 2009_ **COC/PEFC™** Program for endorsement of forest certification schemes. El esquema más difuso y famoso en todo el mundo por lo que concierne la gestión forestal sostenible.
- › 2010_ **OHSAS 18001** sistema de gestión para la seguridad y salud laboral.
- › 2015_ **FSC Forest Stewardship Council: Forest For All Forever: www.ic.fsc.org**

Die **Gruppe Garofoli** setzt seit jeher auf Qualität, und in diesem Sinn auf eine nachhaltige, umweltverträgliche Firmenpolitik. Eine Unternehmensphilosophie; die sich unter allen Aspekten als zielführend und gewinnbringend erwiesen hat.

- › 2001_ **ISO 9001** Qualitätsmanagementsystem.
- › 2009_ **ISO 14001** Umweltmanagementsystem.
- › 2009_ **COC/PEFC™** Program for endorsement of forest certification schemes. Das bekannteste und weltweit am meisten genutzte Konzept zur nachhaltigen Bewirtschaftung und Nutzung der Wälder.
- › 2010_ **OHSAS 18001** Arbeitsschutzmanagement-System.
- › 2015_ **FSC Forest Stewardship Council: Forest For All Forever: www.ic.fsc.org**

Группа **Garofoli** всегда заботилась о качестве, способствовала экологически рациональному развитию своего бизнеса, придерживаясь твердой стратегии, связанной с защитой окружающей среды. Такой подход позволил группе добиться важных результатов.

- › 2001_ **ISO 9001** Система менеджмента качества.
- › 2009_ **ISO 14001** Система экологического менеджмента.
- › 2009_ **COC/PEFC™** Program for endorsement of forest certification schemes. Самая широко распространенная и известная программа в мире по экологически рациональному управлению лесными богатствами.
- › 2010_ **OHSAS 18001** Система менеджмента техники безопасности и охраны здоровья на рабочем месте.
- › 2015_ **FSC Forest Stewardship Council: Forest For All Forever: www.ic.fsc.org**



Tutti i modelli possono subire in qualsiasi momento senza preavviso qualche lieve variazione nelle sezioni, nella struttura, nel disegno e nel colore; pertanto, qualora a nostro insindacabile giudizio resti immutata l'estetica complessiva e la solidità della porta, il cliente non potrà recedere dal contratto, né avrà diritto a sconti o abbuoni particolari. Tutte le essenze, i colori e le trasparenze dei vetri, particolari dei modelli e modelli delle porte illustrati nel presente catalogo sono da ritenersi indicativi e possono subire modifiche.

Tous les modèles peuvent subir, à tout moment et sans préavis, de légères variations dans les sections, la structure, le design et la couleur; par conséquent, lorsque l'esthétique globale et la solidité de la porte restent telles qu'elles selon notre jugement sans appel, le client ne pourra annuler le contrat ni aura le droit à réductions ou remises particulières. Tous les essences, teintes et transparences des vitres, détails des modèles des portes illustrés dans ce catalogue sont à considérer comme indicatifs et peuvent être sujets à modifications.

Der Hersteller behält sich das Recht vor, an allen Modellen jederzeit ohne Vorankündigung geringfügige mass-, struktur-, design- und farbänderungen vorzunehmen; sofern nach dem unanfechtbaren Ermessen des Herstellers dadurch weder die Gesamtoptik noch die Robustheit der Tür beeinträchtigt werden, hat der Kunde kein Recht auf Stornierung des Auftrags und/oder Preisnachlässe und/oder Gutschriften jeglicher Art. Alle Hölzer, die Farben und die Transparenzen der Gläser, Details der Modelle und Modelle der in diesem Katalog abgebildeten Türen haben reinen Beispielcharakter, Abweichungen sind daher möglich.

All models may be subject to slight variations in section, structure, design and colour at any time, without advance notice; therefore, if the overall appearance and solidity of the door remains unchanged in our unquestionable judgement, the client may not withdraw from the contract, nor be entitled to special discounts or rebates. All of the woods, coloured and transparent glass, door models and details of the models illustrated in this catalogue are merely indicative and may be subject to modification.

Todos los modelos pueden sufrir, en cualquier momento y sin previo aviso, leves modificaciones en las secciones, la estructura, el motivo o el color; mientras estas modificaciones, a juicio inapelable del fabricante, no alteren la estética general ni la solidez de la puerta, el cliente no podrá rescindir el contrato ni tendrá derecho a descuentos o bonificaciones de ningún tipo. Todas las maderas, los colores y las transparencias de los cristales, el diseño de las puertas y los respectivos detalles ilustrados en este catálogo deben considerarse indicativos y pueden sufrir modificaciones.

Все модели могут претерпеть в любой момент и без предупреждения небольшие изменения сечений, конструкции, дизайна и цвета. Поэтому, если по нашему неоспоримому мнению общий вид и прочность двери не меняются, клиент не имеет права расторгнуть контракт, а также требовать скидку или специальную компенсацию. Все породы древесины, цвета, степень прозрачности стекла, детали моделей и модели дверей, представленные в этом каталоге, должны считаться ориентировочными и могут претерпеть изменения.



Garofoli SpA
Via Recanatese 37
60022 Castelfidardo
AN Italia

T +39 071 72 71 71
F +39 071 78 03 80
info@garofoli.com
www.garofoli.com



Per scoprire novità, prodotti
e soluzioni scansiona il QR Code.
Scan the QR Code to discover news,
products and solutions.